

BEATA VOGT*

CREATING THEORETICAL MODELS OF VAULTS WITH THE USE OF AUTOCAD SOFTWARE, ON THE EXAMPLE OF BARREL VAULTS

TWORZENIE MODELI TEORETYCZNYCH SKLEPIEŃ PRZY POMOCY PROGRAMU AUTOCAD, NA PRZYKŁADZIE SKLEPIEŃ KOLEBKOWYCH

Abstract

The paper contains a short history of the evolution of vaults and the principles of creating digital models of barrel vaults with the use of AutoCAD software. It is also richly illustrated with drawings of digital models created in AutoCAD.

Keywords: AutoCAD, vault, barrel vault, digital model

Streszczenie

Praca obejmuje krótką historię rozwoju sklepień oraz zasady postępowania przy tworzeniu modeli komputerowych sklepień kolebkowych przy użyciu programu AutoCAD. Całość bogato ilustrowana rysunkami modeli komputerowych wykonanych w programie AutoCAD.

Słowa kluczowe: AutoCAD, sklepienie, sklepienie kolebkowe, model komputerowy

* Ph.D. Eng. Arch. Beata Vogt, university lecturer at the Department of Descriptive Geometry of Technical Drawing and Engineering Graphics, Faculty of Architecture of The Cracow University of Technology.

Introduction

Architecture has featured various types of vaults – structures with a curvilinear cross-section which serve to cover rooms within a building from the top, supported by columns, pillars and arcades – since ancient times. They are commonly made out of stone, bricks, concrete or reinforced concrete, as well as timber – for instance in the timber synagogue in Wołpa¹ [5], or even out of glass connected with metal, like in the case of the PSE-Operator Building in Konstancin-Bielawa, designed by Czesław Bielecki² [1]. They can have a profound influence on the appearance and architectural expression of an entire building, both in terms of its interior and exterior, like in the Funeral Home and crematorium at the Communal Cemetery in Słupsk, by Cezary Flis³ [4].

Vaulted ceilings first appeared in Ancient Egypt, starting with corbel-vaulted ceilings, like the ones in the Bent Pyramid in Dahshur, the pyramid in Meidum or the Red Pyramid of Dahshur (Ill. 1a, 1b). Some of the oldest vaulted ceilings are corbel vaults, which can be found in the Chapel of Hatshepsut in her temple in Deir el-Bahari (Ill. 1c, 1d)⁴ [10]. Corbel vaults were used in Mesopotamia and Persia, and were constructed using a similar principle to the one used in the corbel arch, covering square or circular rooms.

The first barrel vaults were employed by the Sumerians, and were used underneath the ziggurat in Nippur in Babylonia, constructed out of fired ceramic tiles bound with clay (Ill. 2) [8]. In Ancient Greece they can be encountered in the form of corbel domes (Mycenaean tombs, including the tombs of Agamemnon⁵ and Clytemnestra (Ill. 1e, 1f) [3], while the only traces of the use of barrel vaults were found on the island of Keos.

The Etruscans introduced **stone voussoirs** into architecture, which were then adopted by the Romans in order to span gates, triumphal arches and construct aqueducts (Ill. 3). It was in Ancient Rome that vaults became used on a larger scale – with the introduction of the **cloister vault**, the **groin vault** and the **Roman dome**⁶ (Ill. 4) [6].

Byzantine builders added their own type of dome, the so-called **byzantine dome**⁷, e.g. the dome of the Hagia Sophia in Constantinople (Ill. 5). The Romanesque period most often employed **barrel and groin vaults** (Ill. 6), supported by walls and pillars, while the Gothic period brought with it the further development of vaults, especially of the groin type,

¹ The prayer room was vaulted with a wonderful multi-level corbel dome (with an octagonal base), supported by four pillars, between which the bema was located. The synagogue was built at the turn of the XVIII century and was burned down by the Germans in June 1941. Currently it is being rebuilt in Biłgoraj, in the Borderland Town that is being built there.

² The entry hall at the edge has been built out of glass and steel and has the shape of an ellipsoid. The two wings of the building unfold from it, while its entirety forms a three-part composition: the beginning – the head, the middle – the body and the end – inspired by the shape of the tail of an airplane.

³ The form of the entrance section is a cross vault with an elevated boss, with a hexagonal base.

⁴ All of the sketches of the vaults were made using AutoCAD, on the basis of three-dimensional models of vaults that were built in it.

⁵ Also called the Treasury of Atreus – the vault of the tomb (14,60 m in diameter, 13,30 m high) were built out of stones that were picked and shaped with great care.

⁶ It is the upper part of a hollow sphere, often with an oculus – the most famous example is the Pantheon in Rome.

⁷ Also called a compound dome or a dome resting on pendentives.

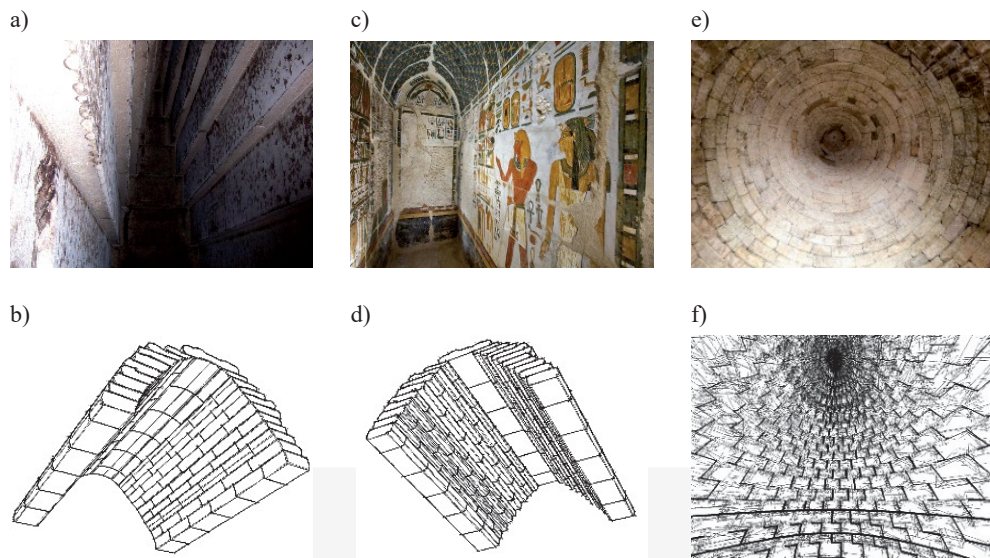

III. 1. Examples of corbel vaults: a) Corbel vault in the Red Pyramid in Dahshur, built for the pharaoh Sneferu of the IV dynasty, b) A digital sketch of a corbel vault, c) Corbel vault in the Chapel of Hatshepsut in her temple in Deir el-Bahari, d) A digital sketch of a corbel vault, e) The interior (dome) of the tomb of Clytemnestra (<http://dzieckowdrodze.com/mykeny-najgorsi-rodzice-swiata> (access: 02.12.2016), f) A digital sketch of a corbel dome

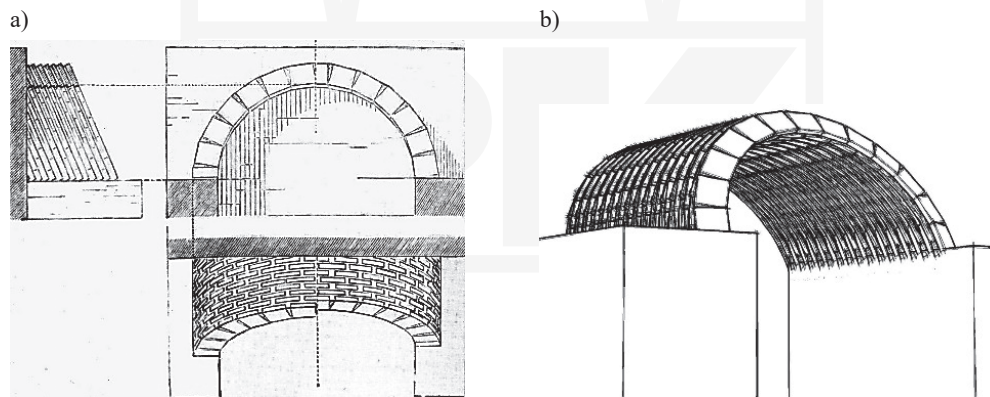

III. 2. A vault constructed out of fired ceramic tiles bound with clay: a) Three views of a barrel vault (source: [https://en.wikipedia.org/wiki/Vault_\(architecture\)](https://en.wikipedia.org/wiki/Vault_(architecture)), author: MOSSOT), b) Perspective drawing of the vault

by making them taller (and giving them the shape of a pointed arch). New variations of the groin and rib-groin vaults were introduced through the introduction of ribs and ever smaller divisions of the space between them, in the form of the **tripartite vault**⁸, the **multipartite**

⁸ Also called the “Piast” vault or the nine-part vault.

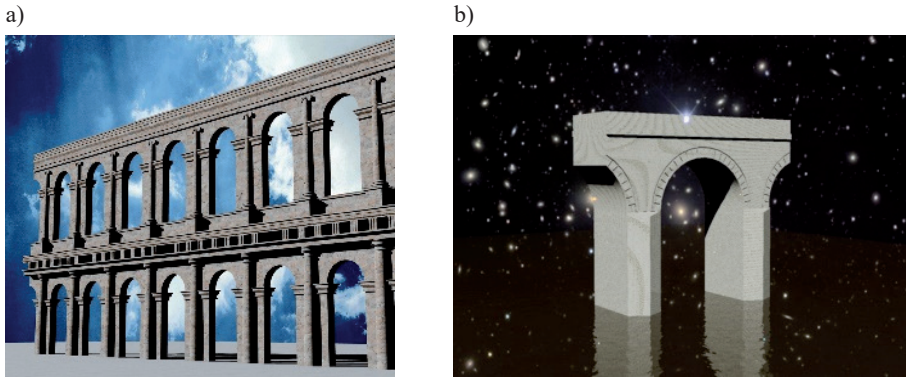

III. 3. Models of structures which employ arches

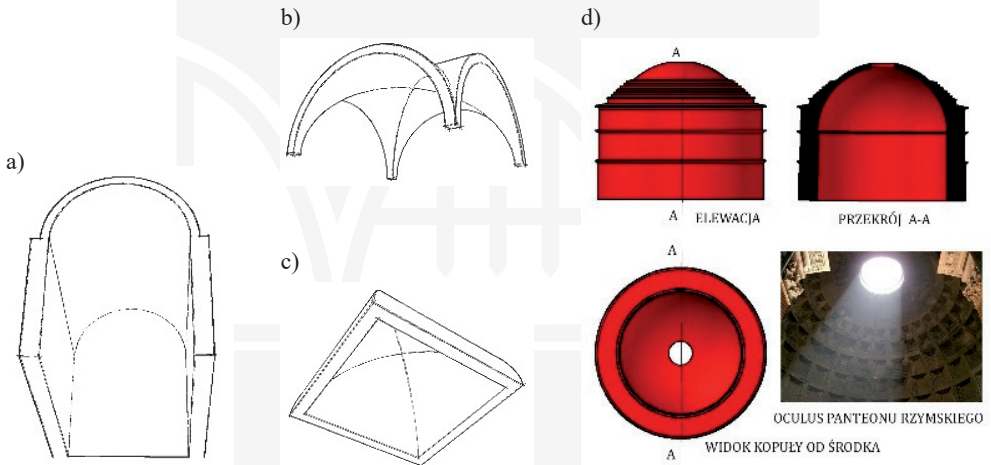

III. 4. The most common types of vaults used in Ancient Rome: a) barrel vault, b) groin vault, c) cloister-vault, d) Roman dome – floor plan and cross-section

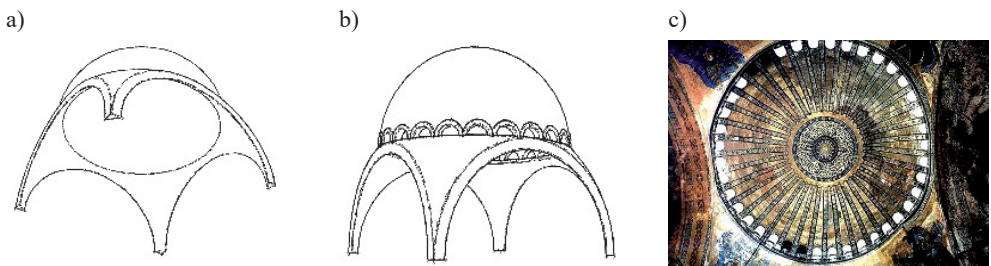

III. 5. Byzantine compound dome: a) Digital sketches of a byzantine compound dome, b) Digital sketches of a byzantine compound dome with a ring of windows at its base, c) View of the interior of a byzantine compound dome – the dome of the Hagia Sophia (<http://www.agiasofia.com/archit.html> (access: 18.04.2016))

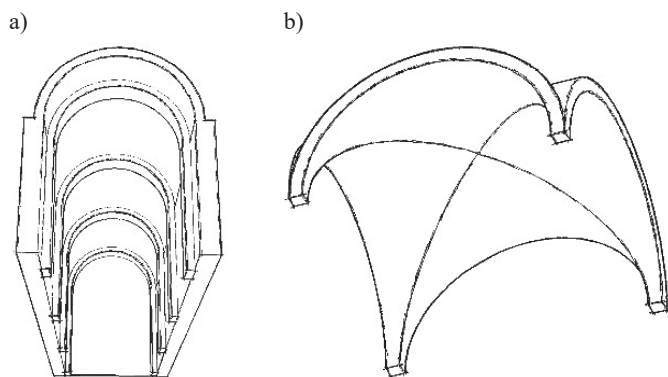

III. 6. Digital sketches depicting examples of vaults used during the Romanesque period:
a) Barrel vault with transverse arches, b) Groin vault

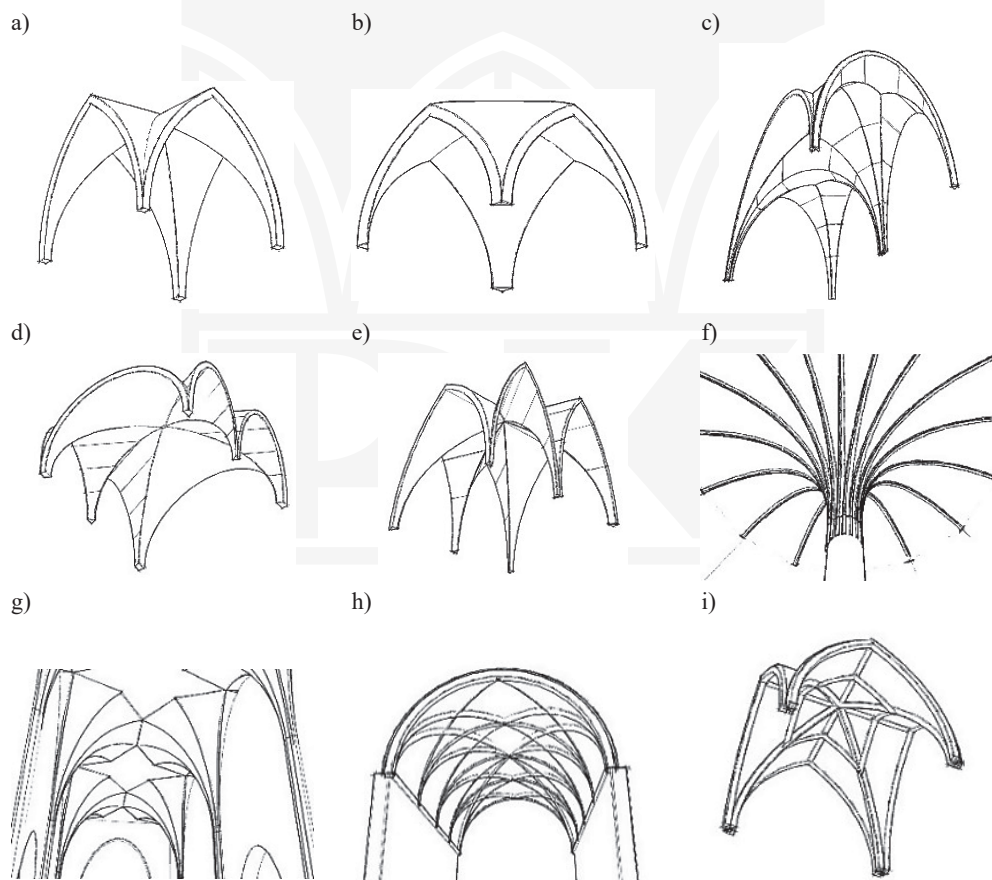

III. 7. Digital sketches of gothic vaults: a) groin vault with pointed arches, b) open cloister-vault, c) tripartite vault, d) sexpartite vault on a square base, e) cross sexpartite gothic vault on a square base, f) pillar fan vault, g) fan vault, h) net vault, i) stellar vault

vault⁹, the **net vault**, the **stellar vault**, the **pillar-based fan vault** and the **fan vault** (Ill. 7). The introduction of very fine divisions and the replacement of lierns with curvilinear surfaces – saw the introduction of the **diamond vault**¹⁰.

The Renaissance was a period when **barrel vaults with lunettes** and **tray ceilings** were most often used. It also saw the introduction of the **renaissance dome**¹¹, e.g. the dome of the Santa Maria del Fiore cathedral in Florence (Ill. 8) [7, 9].

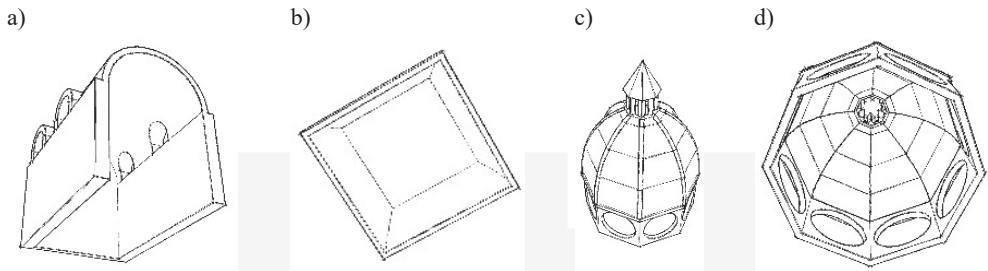

Ill. 8. Digital sketches of renaissance vaults: a) Barrel vault with lunettes, b) Tray ceiling, c) Renaissance dome viewed from the outside, d) The interior of a Renaissance dome

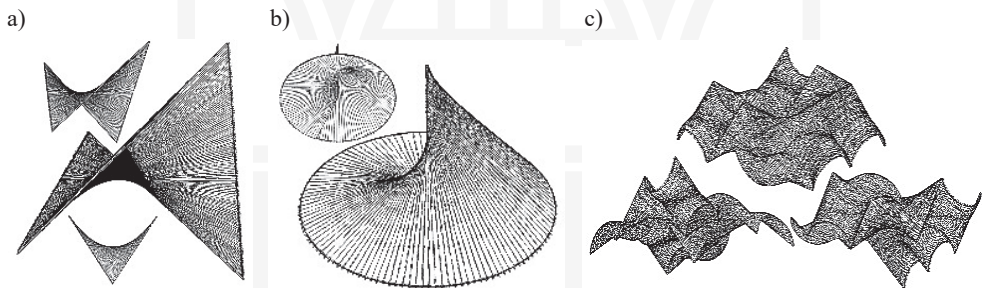

Ill. 9. Digital sketches of thin-walled vaults

The following periods feature the use of vaults that were known in earlier times, with geodesic domes and various thin-walled shells based on circular, parabolic, hyperbolic and other curves being used from the XX century onwards (Ill. 9).

It is worth adding that the cultures which originated in the region of the Mediterranean Sea were not the only ones to use vaults. In Mesoamerica, for instance, **corbel vaults** were used as ceilings in burial crypts (The Temple of Inscriptions in Palenque) or rooms (Temple of Warriors – Templo de los Guerreros in Chichén Itzá) or arched passages – gateways (Ill. 10).

⁹ For instance a sexpartite vault with a square base.

¹⁰ Forming early examples of deep beams (thin-walled covers made out of flat elements – with the shape of a rectangle, trapeze or triangle, connected at a given angle).

¹¹ Which is based on the cloister-vault, which means it was based on cylinders rather than a sphere.



III. 10. Corbel vaults in Mayan buildings: a) The tomb of K'inich Janahb Pakal I in the Temple of Inscriptions (http://przedkolumbem.blogspot.com/2013/01/miasta-majow-palenque-stan-chiapas_15.html (access: 18.04.2016) in Palenque, b) The Southern Temple, the so-called Nunnery in Uxmal http://www.mexicoentero.pl/pages/przewodnik_jukatan/strefy_archeologiczne/uxmal (access: 21.06.2015), c) Digital sketch of a corbel vault

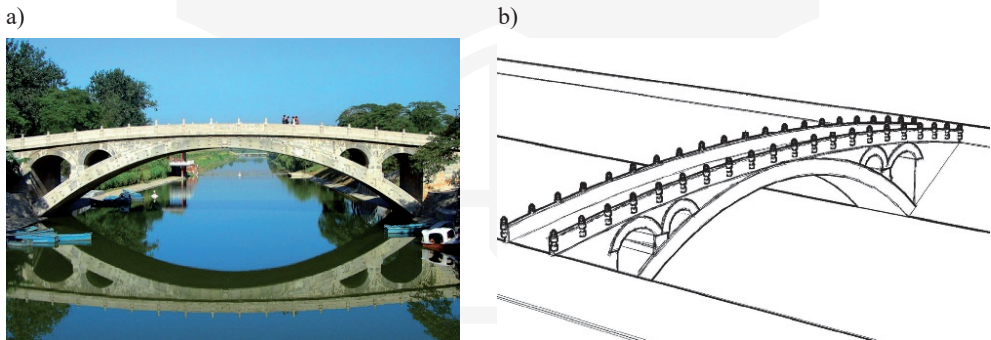

III. 11. The Zhaozhou stone arched bridge in Zhao Xian, from the year 605 (China): a) a photograph of the bridge, b) digital sketch

Vaults were also present in the Middle Kingdom. For instance, over ten tombs from the Han dynasty period (206 BCE – 220 BCE) have been found. Many of them feature arches, vaulted chambers and roofs in the form of domes [11]. Another example is the arched Zhaozhou stone bridge in Zhao Xian, Hebei province, built in the VII century AD – its vault is shaped in the form of a surbased arch (III. 11) [2]. This is not an isolated example.

The digital modelling of barrel vaults

When designing or studying buildings and structures, it was and still is common to build a model of them. In the past, these were realistic models made out of various materials, such as: wood, plywood, balsa wood, cardboard or gypsum. Currently, it is increasingly more common to build a digital model.

When building a model of a vault in AutoCAD, we need to remember that “there is no single path to our goal” in this program. Any object can be constructed in a multitude of ways, which means that we need to adopt the approach that is the fastest or the simplest in any given case. However, regardless of the approach that we are going to adopt, the first thing to do is to determine the structure of a vault, which is associated with its geometry. This paper is going to illustrate the stages of the construction of digital models of barrel vaults, which are a basis for the modelling of other types of vaults, such as cross vaults, pillar-based fan vaults or cloister vaults in all of their myriad variations.

A barrel vault is created when its head, in the form of an arch (Ill. 12) is extruded along a path (which forms the axis of the vault), with or without increasing its radius.

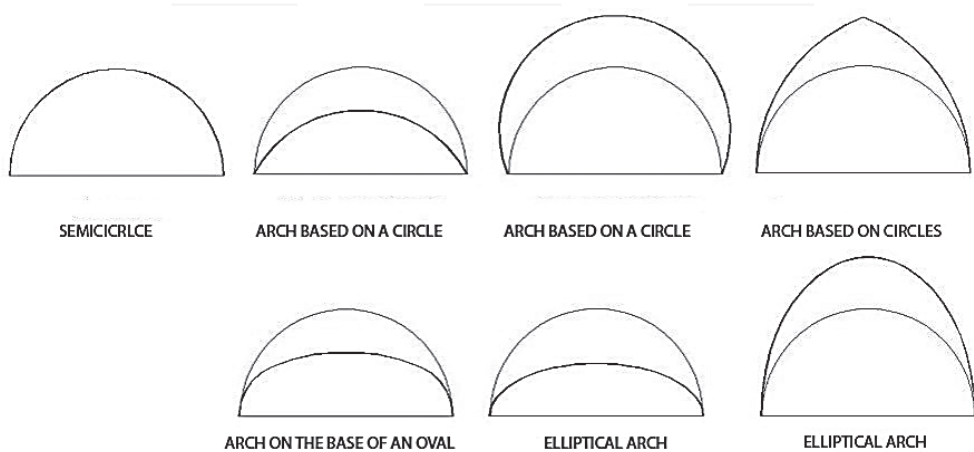

Ill. 12. The various types of arches which can serve as the shape of the head of a barrel vault

In the past, barrel vaults were usually made out of stones in the shape of a voussoir, bound in a running pattern, but they can also be made out of brick or concrete. Such a vault forms a single, continuous half-cylinder, or it can be divided into a series of smaller sections with the use of transverse arches.

Vaults of this type can be categorised depending on the shape of the head of the barrel vault – the arch in their transverse cross-section (Ill. 12) – into: **surbased barrel vaults** (the shape of the transverse cross section is a fragment of a circle), **raised barrel vaults** (the shape of the transverse cross section is one side of an ellipse – standing on its shorter axis), **flattened barrel vaults** (the shape of the transverse cross section is one side of an ellipse – standing on its longer axis) or the **pointed barrel vaults** (the shape of the transverse cross section is composed out of two arches which cross each other, the diameter – in the case of a circle – or axis – in the case of an ellipse – of which is larger than the distance between the longitudinal walls of the room covered by the vault).

The creation of a model of a vault can involve the following steps:

- the extrusion of the line of the shape of the vault, providing us with a surface that has the desired shape – the shape of the vault is obtained by using such commands as: *Circle*, *Ellipse*, *Polyline*, *Trim*, *Join*, and then, using the *Extrude* command, using

a given length, we can obtain a surface with the desired shape which depicts our vault. Afterwards, we should give it an appropriate thickness – convert the surface into a solid using the commands *Modify* → *3D operations* → *Thicken* (Ill. 13a, b).

- the extrusion of a cross section created from a line which delineates the shape of the vault and its horizontal closure, creating a 3D solid, which has three walls that are surfaces, while the remaining part has the shape of the desired vault. Afterwards, we can convert the solid into an empty shell with a wall of a desired thickness by removing excess walls with the use of the *Shell* command (Ill. 13c, d).

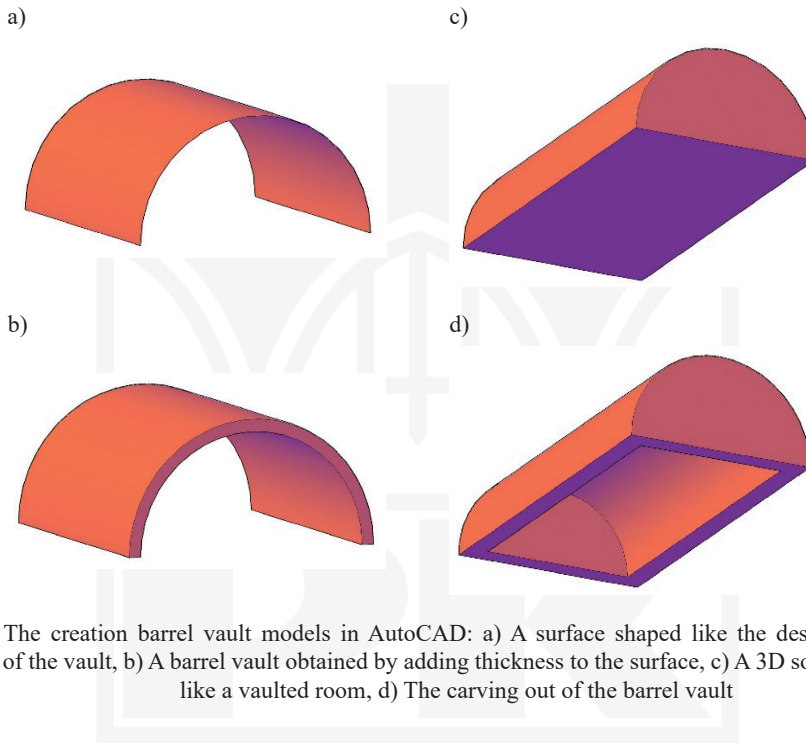

Ill. 13. The creation barrel vault models in AutoCAD: a) A surface shaped like the desired shape of the vault, b) A barrel vault obtained by adding thickness to the surface, c) A 3D solid shaped like a vaulted room, d) The carving out of the barrel vault

In addition, we can divide this type of vault into the following categories:

- **conical barrel vaults**, in which the vault covers a room with a trapezoid floor plan. We can create a model of such a vault using various approaches. For instance, we can create it by revolving the cross section of the floor plan of one of the walls placed at an acute angle to the axis of the room (*Revolve*) creating a 3D solid (Ill. 14a), or one of the arms of the trapeze of the floor plan of the room (*Revolved surface*) creating a mesh, which should then be converted into a solid by thickening it (*Thicken*). Another approach is the creation of a circular cone (*Cone*), with the floor plan of the room being a fragment of the cross section of the cone at its axis, and then carving the cone (using the *Shell* command) and cutting away its redundant parts (the parts located outside of the floor plan) (Ill. 14b). We can also use meshes to make the model, in the form of the *Ruled surface* command (Ill. 14c), *Edge surface* (Ill. 14d), and then assigning them with a thickness afterwards (*Thicken*) in order to convert them to solids;

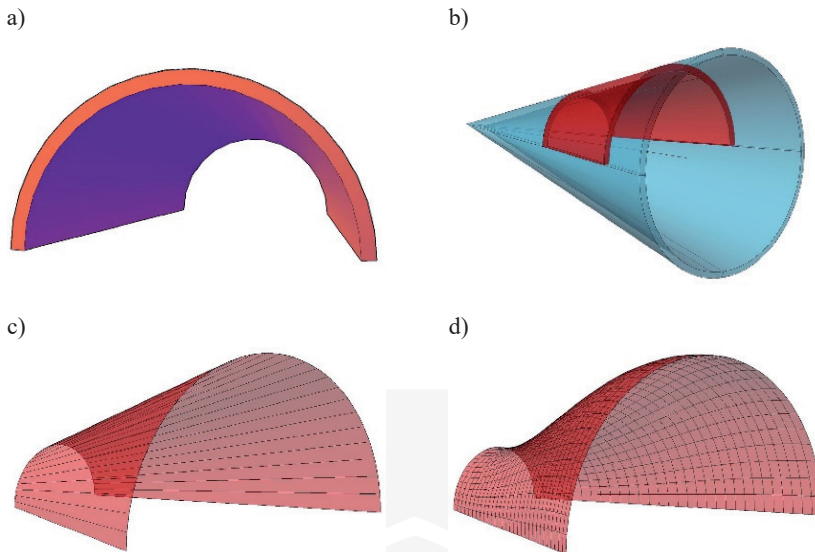

III. 14. Examples of methods of creating a model of a conical barrel vault in AutoCAD: a) The solid is created by revolving the cross section of a wall, b) The vault as a fragment of a carved out cone, c) The shape of the vault in the form of a ruled surface (mesh), d) The shape of the vault in the form of an edge surface (mesh) – in this case we have an example of a conical barrel vault with a deformed barrel

- **raised barrel vault**, in which the axis of the barrel is at an angle to the floor, which results in walls of variable height (Ill. 15). Such a vault is usually used in staircases. We can also construct a model of such a vault in a number of ways. For instance, we can build the model of our vault by drawing a shape of the outline of the cross section of the walls and the vault in their highest position by using the *Extrude* command along a path, which is a line placed at a given angle. All that we need to do afterwards is cut away the redundant fragments of the walls by using either the *Cut* or the *Subtract* command. Another approach is the creation of a surface in the shape of the desired vault by *Extruding* an arc along a path that is analogous to the one in the first example. We should then assign our vault with a thickness by using the *Thicken* command – thus turning a surface into a solid, extruding the walls and or perhaps the vault itself by using the *Extrude* surface command. Finally, we cut away the excess elements. We can also construct a model of this type of vault by making it a mesh (a ruled surface). In order to do this, we need two defining curves made from arches at each end of the vault, which enables us to use the *Ruled surface* command. After creating the mesh, we need to thicken it by turning it into a solid and model the walls. In order to do so, we can construct box-shaped solids (using the *Box* command) with bases of the same shape as the walls on the floor plan, and then cut them along the incline of the vault;

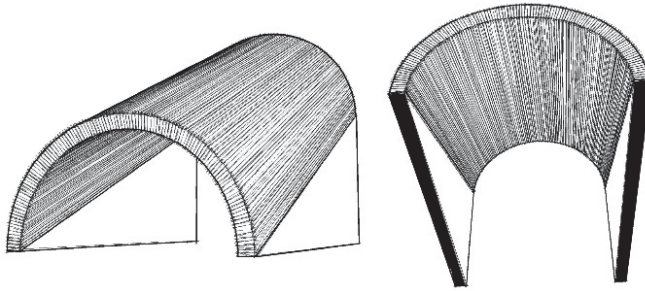

Ill. 15. A sketch of a raised barrel vault made in AutoCAD

- **straight barrel vaults** are constructed so that the axis of the vault is a straight line that is perpendicular to the head of the vault. A model of such a vault can be easily made by drawing its transverse cross section, and then extruding it along a desired length. Due to the fact that in barrel vaults (in the real world) the walls bear the vertical load (the weight of the vault) and the horizontal load (lateral forces), it is advised to make them thicker than the vault itself. Should this not be done during the drawing of the transverse cross section of the room, it can be performed after creating the solid by extruding it to a desired thickness (using the *Extrude surface* command), or by placing additional box-shaped solids and combining them with the existing model (Ill. 16);

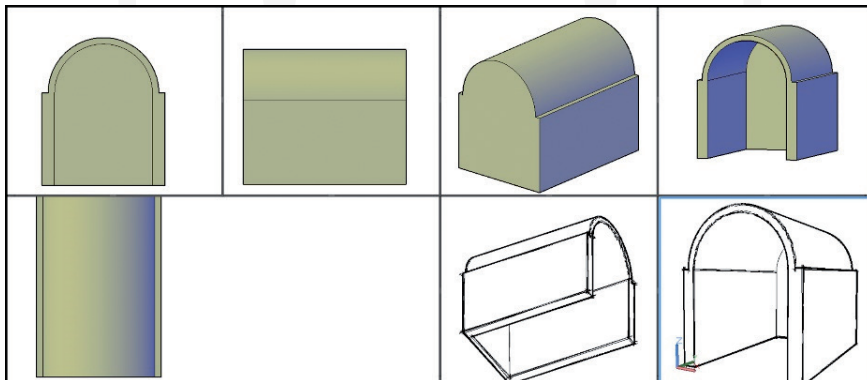

Ill. 16. Model of a straight barrel vault with widened walls absorbing the load from the vault, constructed in Autocad – to the left we can see the three basic views, while to the right there are axonometric and perspective views of the model of the vault

- **slanted barrel vaults** are vaults in which the axis of the vault is a straight line placed at an angle to the walls of the room. When creating a model, we need to begin by drawing the floor plan of the room, the axis of the vault¹² that is being modelled and

¹² The example features a vault axis that is diagonal to its floor plan, but it can be set at any angle.

the shape of the bay¹³ (two circles that share the same centre – the internal outlines the shape of the vault while the external delineates its thickness). Afterwards, the circles are then rotated along the axis of rotation, which is perpendicular to the axis of the vault and which crosses their centrepoints. We define the thickness of the walls of the room and move both circles along with their diameter (the axis of rotation when rotating them into a vertical position) outside the room in the direction of the axis of the vault. By extruding the internal circle and the floor plan of the room we then obtain a cylinder and a box, which we then intersect. These operations are then repeated on the external circle and the rectangle that outlines the thickness of the walls. Finally, we should subtract the internal solid from the external solid in order to obtain a model of this vault (Ill. 17);

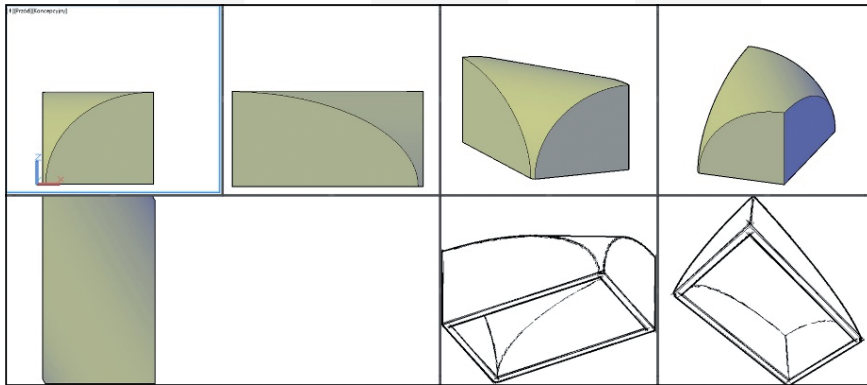

Ill. 17. A model of a slanted barrel vault arch made in AutoCAD – to the left we can see the three basic views, while to the right are axonometric and perspective views of the model of the vault

a)

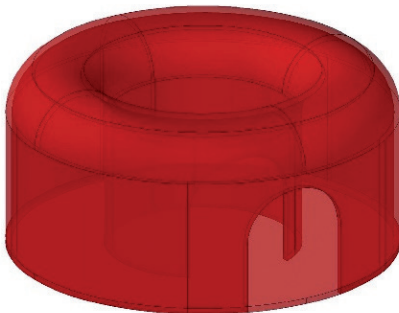

b)

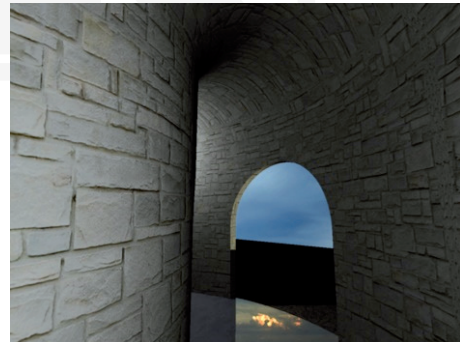

Ill. 18. A torus-shaped barrel vault: a) Digital model of the vault, b) A rendering of the interior

¹³ The model in the example is going to be based on a cylinder, the axis of which is the same as the axis of the vault, so the transverse cross section is going to be a semicircle.

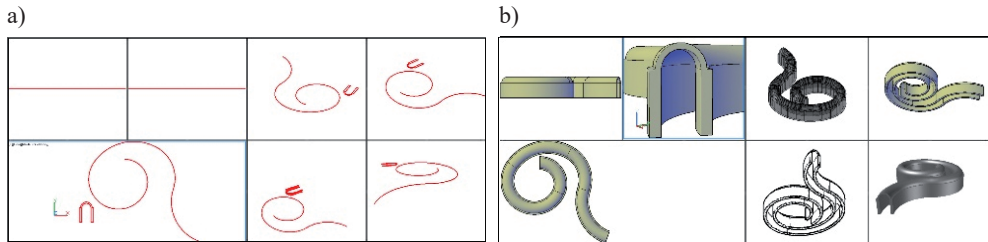

III. 19. Creating a torus-shaped barrel vault with a freeflowing path: a) Using the outline of the transverse cross section as the element to be extruded and the axis of the vault as a flat, smooth line composed of a series of arcs which smoothly merge with each other, b) The model of the vault obtained by extruding the cross section of a normal vault along the given path

- a **torus-shaped barrel vault** is a type of vault in which the axis of the vault is a circle or a fragment of it. Such a room usually surrounds a courtyard or some other type of central room. In order to build a model of this vault, we need to use the *Torus* command and then cut away any excess fragments and sculpt the resultant solid into the desired shape (III. 18), or draw a path and a transverse cross section of the vault (or just the shape of the vault, although it will require assigning a thickness to the resulting surface), and then extrude it along a path (*Extrude*) (III. 19).
- A **spiral-shaped barrel vault**, when the axis of the vault is a line in the shape of a spiral. When creating a model of this type of vault we need to draw a transverse cross section of a vault (which is its normal cross section), as well as a path, which is going to be a helix (using the *Helix* command), along which the cross section is then extruded (III. 20).

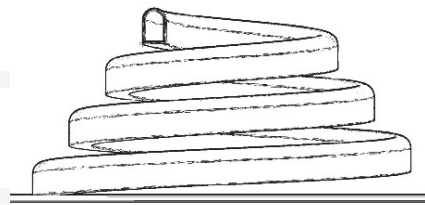

III. 20. A sketch of a spiral-shaped barrel vault

Other variants of the barrel vault include the **barrel vault with lunettes** (III. 21), the **barrel vault with transverse arches** (III. 22) as well as the **net vault** (III. 23).

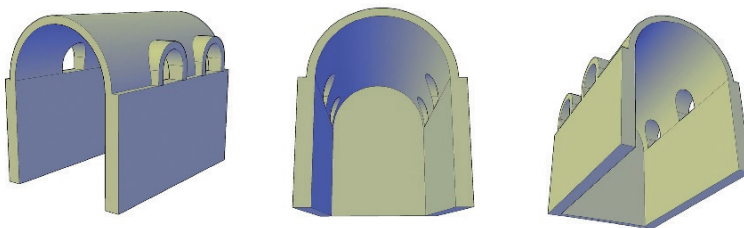

III. 21. Barrel vault with lunettes

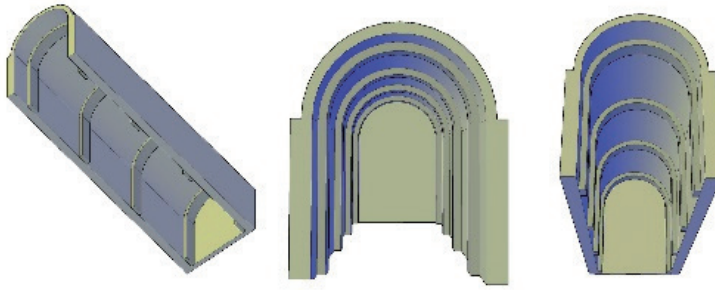

III. 22. Barrel vault with transverse arches

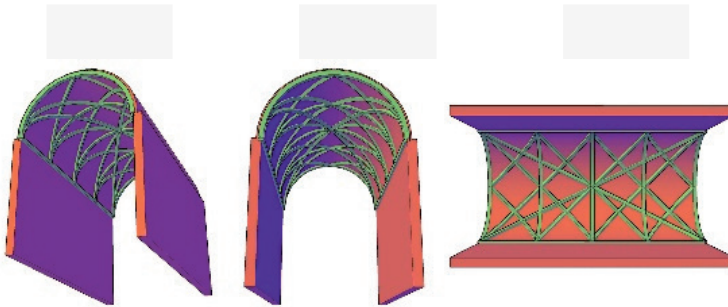

III. 23. Net vault

The first of these, **the barrel vault with lunettes**, is a long barrel vault with smaller barrel vaults¹⁴ cutting into it from the sides, of a smaller diameter than the main vault itself. When creating a model of such a vault, we should first create a model of the main barrel vault and then model each lunette, so that they can be later combined into a single model. The lunettes are simply smaller barrel vaults, and the basic problem that needs to be solved here is their connection to the main vault.

When creating a model of a **barrel vault with transverse arches**, we should begin by creating the barrel vault and then focus on modelling the vault belt, multiplying it, and thus dividing the main vault into sections.

When creating a model of the third type of vault, **the net vault**, we should also start by modelling the barrel vault, on which we will then place a pattern of criss-crossing ribs. In order to do so, we need to place lines on the barrel vault, which will form the desired pattern, and which will simultaneously form paths for the cross sections of the ribs that are going to be extruded along them. Combining the barrel vault with the resultant latticework will result in a net vault.

¹⁴ It is then called a lunette vault.

Conclusion

Using barrel vaults as a base, we can create various other types of vaults, using cylinders, cones or tori (Ill. 24). The principles of creating them are analogous to the ones used in creating models of barrel vaults. This is why they will not be discussed in this paper.

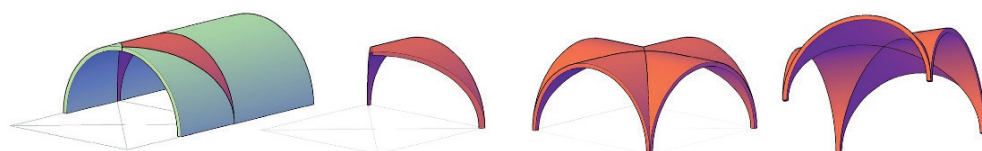

Ill. 24. The use of a barrel vault in the modelling of a cross vault

The creation of various types of digital models is a very important in the professional life of architects and engineers. After creating a virtual model of, for instance, a vault, they can thoroughly analyse it. This allows them to see not only the solid, but also “enter” the interior of a structure and check how a given room is going to be perceived, for instance, from the perspective of a standing person. A model, once built, can be altered by changing such parameters like its material, colour, lighting etc. A designer can thus change its properties multiple times, obtaining comprehensive information about its surface area, volume and many other physical properties each time.



Ill. 25. An example of the changes in the appearance of an interior caused by materials, colour and lighting

It also pays to remember and reuse tried and tested structures which had been developed in the past, and even improve upon them.

References

- [1] *Budynek PSE-Operator w Konstancinie-Bielawie*, http://www.ronet.pl/index.php?mod=realizacje&realizacja_id=420 (access: 17.04.2016).
- [2] *Most Zhaozhou*, <http://www.drogi-mosty.pl/najwspanialsze-mosty-%C5%9Bwiata/mosty-%C5%9Bredniowieczne/most-zhaozhou> (access: 17.07.2016).

- [3] *Mykeńskie groby*, <http://www.wiw.pl/kulturaantyczna/twardecki/termin.asp?et=00256> (access: 15.07.2016).
- [4] *Na ostatnią drogę*, http://www.sztuka-architektury.pl/index.php?ID_PAGE=35984 (access: 17.04.2016).
- [5] Piechotkowie M.K., *Bóżnice drewniane*, Budownictwo i Architektura, Warszawa 1957.
- [6] Szolginia W., *Architektura*, Sigma NOT, Warszawa 1992.
- [7] Śnieżyńska A., *Brunelleschi i jego – dosłownie i w przenośni – największe dzieło*; <http://sniezynska.pl/wszystkie/kultura/brunelleschi-i-jego-doslownie-i-w-przenosni-najwieksze-dzieło> (access: 31.07.2016).
- [8] *The Encyclopaedia Britannica*, Eleventh edition, Vol. 27, 1911, 956–961.
- [9] *The Secrets of the Florentine Dome by Karel Vereycken 2013*, <http://schillerinstitute.org/educ/pedagogy/2013/vereycken-dome-1.html> (access: 15.07.2016).
- [10] *W Deir el-Bahari otwarto nową ekspozycję. Współautorami architektki z PWr*, Badania i Technologie, Pryzmat, Politechnika Wroclawska; <http://www.pryzmat.pwr.edu.pl/badania/84> (access: 18.04.2016).
- [11] Wang Zhongshu, *Han Civilization*, Translated by K.C. Chang and Collaborators, Yale University Press, New Haven and London 1982.

