

Renata Kłaput

Agnieszka Kocoń

Andrzej Flaga (liwpk@windlab.pl)

Institute of Structural Mechanics, Faculty of Civil Engineering, Cracow University  
of Technology

AIR FLOW FORMATION IN THE INLET OF A CLOSED CIRCUIT BOUNDARY  
LAYER WIND TUNNEL USING THE ONE-SET GUIDE VANES SOLUTION

---

FORMOWANIE PRZEPLYWU POWIETRZA NA WLOCIE TUNELU  
AERODYNAMICZNEGO Z WARSTWĄ PRZYŚCIENNĄ O OBIEGU  
ZAMKNIĘTYM Z UŻYCIEM JEDNOSTOPNIOWEGO UKŁADU KIEROWNIC

**Abstract**

The paper presents tests of wind velocity distribution at the inlet to the working section of a wind tunnel. Unconventional guide vanes were introduced in the construction of the wind tunnel to obtain a uniform air flow in this area.

**Keywords:** wind tunnel, guide vanes, uniform wind velocity distribution

**Streszczenie**

W artykule przedstawiono wyniki badań rozkładu prędkości powietrza na wlocie do tunelu aerodynamicznego. W celu uzyskania jednorodnego strumienia powietrza w tym obszarze wprowadzono niekonwencjonalny układ kierownic.

**Słowa kluczowe:** tunel aerodynamiczny, kierownice, jednorodny rozkład prędkości powietrza

# 1. Introduction

Wind tunnels are commonly used in civil engineering to simulate natural conditions at a model scale [1]. The range of phenomena which can be tested there is broad. Types of investigations include: aerodynamics of structures and buildings, wind characteristics in a boundary layer, wind energy, pedestrian wind comfort and simulation of pollution dispersion.

The wind tunnel at the Cracow University of Technology is an example of such a tunnel. It has a mixed air circulation, open or closed. The basic dimensions of the working section of the wind tunnel are: width 2.20 m, height from 1.40 m at the inflow to 1.60 m at the end of the measurement space, length 10 m (Fig. 1). Four characteristic segments, each of 2.5 m length can be distinguished in the working section.

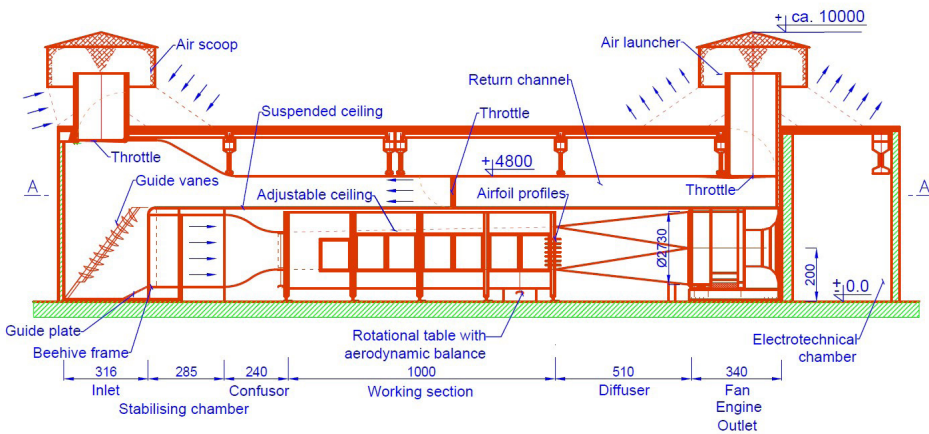

Fig. 1. Side view of the wind tunnel



Fig. 2. Elements at the inlet to the wind tunnel: diagonal openwork shield (a), guide vanes (b), angle of the guide vane inclination (c)

The paper contains detailed tests of the redesign of the existing inlet to the working section. Elements forming an air flow in this part of the wind tunnel had been changed, so it was necessary to test this new configuration. In the previous solution diagonal, openwork shield, whose aim was to reduce undesirable vortexes, was applied (Fig. 2a). It had too slight an influence on the formation of uniform air flow, so this solution required improvement. Therefore unconventional guide vanes were introduced in the construction of the wind tunnel to obtain a uniform air flow at the inlet area of the working section (Fig. 2b). The set consists of 10 guide vanes of the same cross-section. The design of this solution is not the subject of this paper.

New elements in the wind tunnel demanded tests, so investigations were conducted for different arrangements of guide vanes. The final choice was the one which leads to a uniform flow at the inlet section. Trial and error was used to find the optimal arrangement of the guide vanes angles.

## 2. Inlet guide vane arrangement in the wind tunnel

The movement of air in the wind tunnel is caused by an axial fan which sucks it. Air goes back through the return channel and is then directed into the area of the working section by the guide vanes. It goes through a beehive frame, a stabilizing chamber and a confusor. Then – in the beginning of the working section – the mean velocity profile and the turbulence intensity profile characteristic for a specific terrain category are formed. Terrain categories reflect type of the terrain roughness and are defined according to specific standards [e.g. 2, 3] or by different authors [4].

To imitate real wind behaviour in a specific terrain roughness, respective turbulence elements (barriers, spires, blocks) are used. To execute this properly, it is necessary to obtain uniform distribution of wind flow at the starting point of the working section. Mean wind velocity at every point of the cross-section at the inlet to the wind tunnel should be the same. Hence, the essential thing is to direct the air stream in the right way. The key point is the proper arrangement of vanes. So, the main aim of these measurements was to establish uniform air flow distribution at the inlet section of the wind tunnel.

The solution of using guide vanes to direct air flow into the working section is not common in wind tunnels. There is little information concerning the influence of guide vanes arrangement on the distribution of the mean wind velocity [5], but these cannot be directly used in our case because of the specifics of the wind tunnel construction.

Problems of design optimization for wind tunnels have been discussed in many papers: from contraction design [6–8] to wind tunnel shape modification and CFD modelling of the air flow [9–11]. Particularly, wind tunnel configuration with respect to the blockage effect is considered in [12–14].

The solution presented in this paper is not commonly used in closed circuit wind tunnels. A typical construction is based on a few sets of guide vanes which direct the air flow (Fig. 3a). In the Wind Engineering Laboratory at the Cracow University of Technology only one set of guide vanes was applied, which is a new approach in this field (Fig. 3b).

Even though the construction of wind tunnels is discussed in many papers, the need to develop in this area still exists. This paper can provide a new method of forming uniform wind flow in a closed-circuit wind tunnel by using a special arrangement of guide vanes. Due to the lack of data concerning this solution, a wide range of experiments was conducted to select the suitable option for proper guide vanes arrangement.

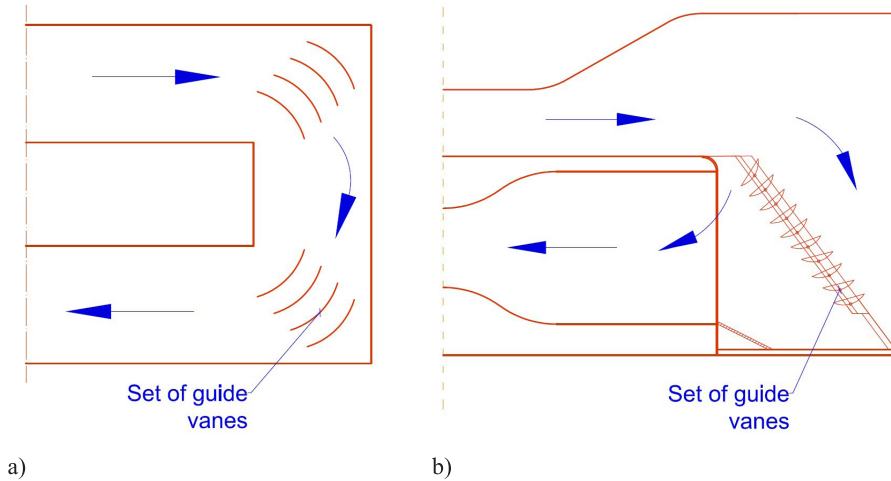

Fig. 3. Scheme of the air circulation in the closed circuit wind tunnel: typical solution of the air circulation with using a few sets of guide vanes (top view) (a); view of the inlet part of the Wind Engineering Laboratory at the Cracow University of Technology – solution of one-set guide vanes (side view) (b)

### 3. Experimental setup

Taking into consideration the set of different configurations, the angles of the guide vanes were changed in each experiment. Air stream velocities were measured at the inlet section of the wind tunnel at a set of measurement points. The purpose of this test was to obtain a uniform velocity distribution at the final configuration. Guide vane angles were measured in the manner illustrated in Fig. 2c.

The measurements were made using a system of pressure electronic scanners of parallel type allowing simultaneous measurements at 64 points. The scanner is built on the base of Motorola MPX2010 piezoresistive pressure sensors. The registration of the wind velocity pressure (dynamic) was made at taps regularly distributed at the inlet to the wind tunnel, at the inlet to the working section and in the working section (Fig. 4). The measured data were converted into the form of the mean wind velocity using the relationship:

$$q = \frac{1}{2} \rho \bar{V}^2 \tag{1}$$

where:  $q$  – dynamic pressure,  $\rho$  – air density;  $\bar{V}$  – mean wind velocity.

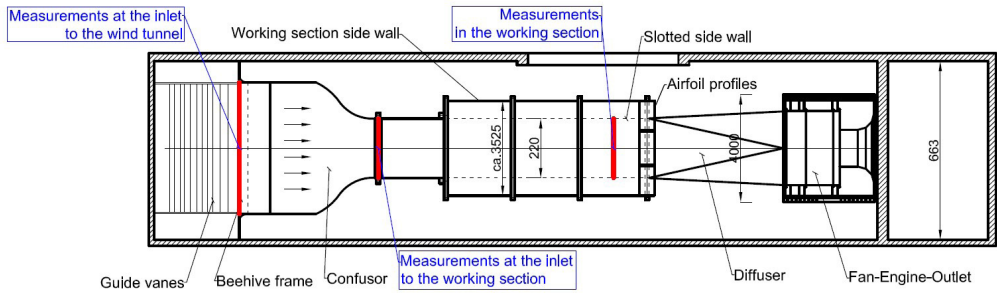

Fig. 4. Top view of the measuring areas in the wind tunnel

The tests were performed in the following conditions: period of signal sampling: 30 s, frequency of signal sampling: 200 Hz, number of time steps in sampling signal: 6000.

The mean wind velocity during experiments was set as equal to about 15 m/s with use of ATU2001 thermo-anemometers cooperating with a National Instruments NI-USB 6009 multifunction data acquisition system. This velocity was measured in the area of the wind tunnel working section.

### 3.1. Measurements at the inlet to the wind tunnel

The wind velocity was measured at 25 taps situated regularly from 50 cm above the floor at the inlet to the wind tunnel, every 40 cm vertically and 80 cm horizontally. The distribution of the measurement points is presented in Fig. 5. Taps were localized in the section of beehive frame (comp. Fig. 1, Fig. 4).

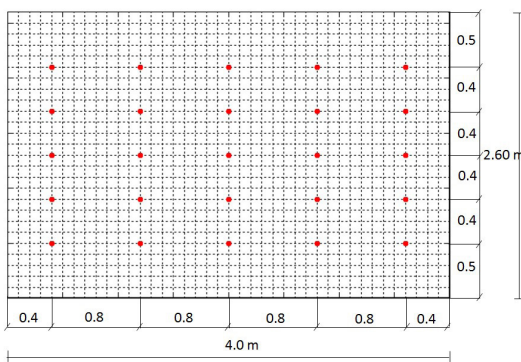

a)

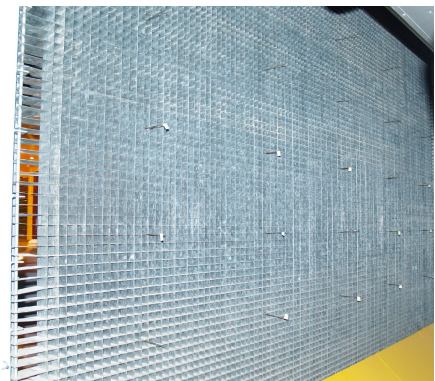

b)

Fig. 5. Distribution of the measurement points at the inlet to the wind tunnel scheme (a), view in the wind tunnel (b)

### 3.2. Measurements at the inlet to the working section

The mean wind velocity was measured at 42 taps situated regularly from 10 cm above the floor in the working section, every 20 cm vertically and 30 cm horizontally. The distribution of the measurement points at the inlet to the working section is presented in Fig. 6. Taps were localized in the section between the confusor and the working section (comp. Fig. 1, Fig. 4).

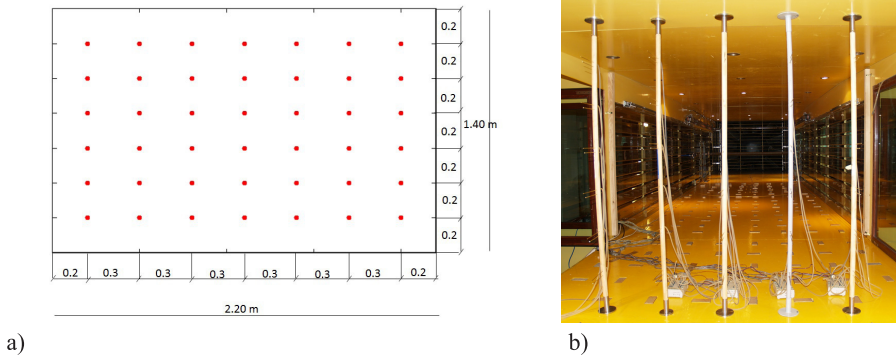

Fig. 6. Distribution of the measurement points at the inlet to the working section (view from the inlet side of the wind tunnel): scheme (a), view in the wind tunnel (b)

### 3.3. Measurements in the working section

The third series of tests were carried out in the fourth segment of the working section where models are situated during wind tunnel tests. The mean wind velocity was measured at 42 points situated regularly in the cross-section as in case 3.2. No turbulence elements (spires, barriers, blocks) were used in simulation of terrain roughness.

## 4. Results of experiments

In the further analysis, the situation before modification of the wind tunnel (without guide vanes) is called the initial state. In this case, there were no elements at the inlet section to the wind tunnel which could configure the direction of the air stream. The final state means the situation obtained after installing the guide vanes and its proper arrangement achieved by trial and error, when wind velocity distribution at the inlet section to the wind tunnel is uniform.

At first, the comparison of the mean wind velocity distributions in these two states – initial and final – is presented.

### 4.1. Measurements at the inlet to the wind tunnel

The distribution of the mean wind velocity at initial and final state at the inlet to the wind tunnel is presented in Figs 7, 8 respectively. Results of the measurements are presented

by two-dimensional distribution (a) and by values of the mean wind velocities in the measurement points (b).

The final guide vanes arrangement is presented in Fig.9. Angles of guide vanes inclination are designated on the left side of the guide vanes, while the guide vanes numbers are presented on the right. Distribution of the mean wind velocity at the final state at the inlet to the wind tunnel in the view of the whole tunnel space is also shown (Fig. 8 c).

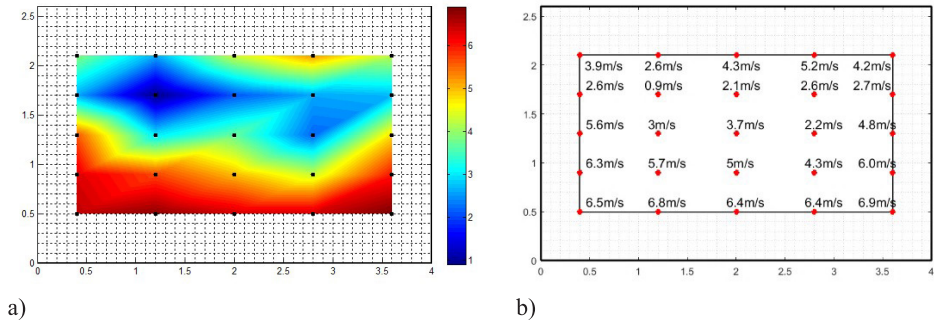

Fig. 7. Distribution of the mean wind velocity [m/s] at the initial state at the inlet to the wind tunnel (before installing the guide vanes): 2D distribution (a), velocity values in the measurement points (b)

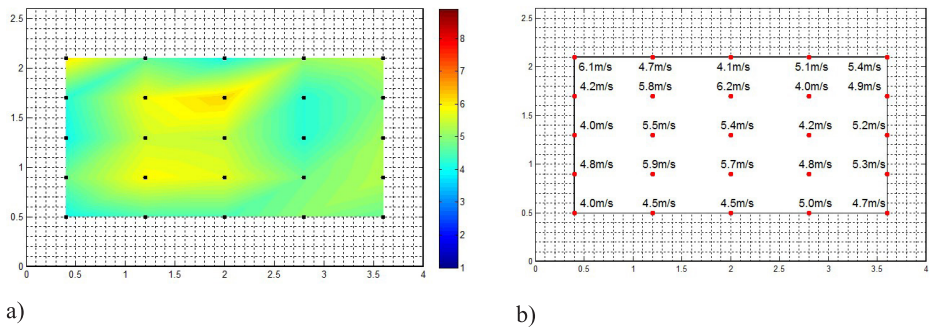
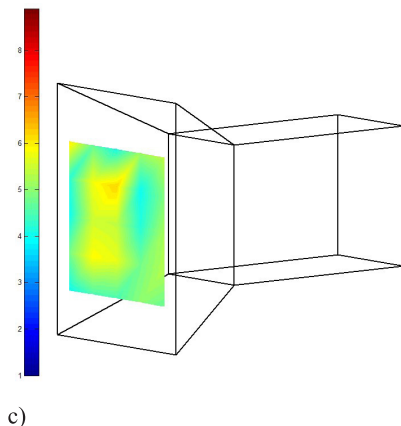

Fig. 8. Distribution of the mean wind velocity [m/s] at the final state at the inlet to the wind tunnel (after installing the guide vanes): 2D distribution (a), velocity values in the measurement points (b), 2D distribution in the view of the whole tunnel space (c)



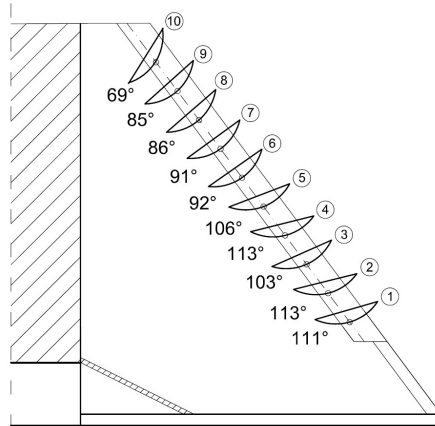

Fig. 9. The final setting of the inclination angles of guide vanes

Mean wind velocity distribution at the inlet area to the wind tunnel in the initial situation (Fig. 7) was not uniform. Velocities in the lower part of the measurement area were significantly higher than in the upper. This was a very undesirable situation and therefore changes aiming to improve it had to be made. After installing a set of guide vanes and their proper arrangement a uniform distribution of mean wind velocity can be observed (Fig. 8).

#### 4.2. Measurements at the inlet to the working section

The distribution of the mean wind velocity in the initial and final states at the inlet to the working section is presented in Figs 10, 11 respectively. As before, two-dimensional distribution and values of the mean wind velocity in each measurement point are presented.

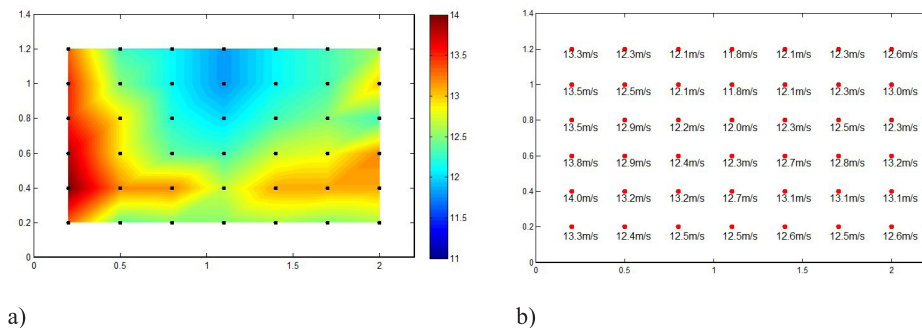

Fig. 10. Distribution of the mean wind velocity [m/s] at the inlet to the working section (before installing the guide vanes): 2D distribution (a), velocity values in the measurement points (b)



Similarly to case 4.1, a significant difference between the distribution of the mean wind velocity before and after installing the set of guide vanes can be observed. We were able to achieve a uniform distribution, as can be seen in Fig.11. It must be pointed out that mean velocities in this case are higher than those measured at the inlet to the wind tunnel. The air stream flows through the confusor on its way from the inlet to the wind tunnel to the inlet to the working section. The confusor increases wind velocity and improves the uniformity of its distribution in the cross-section.

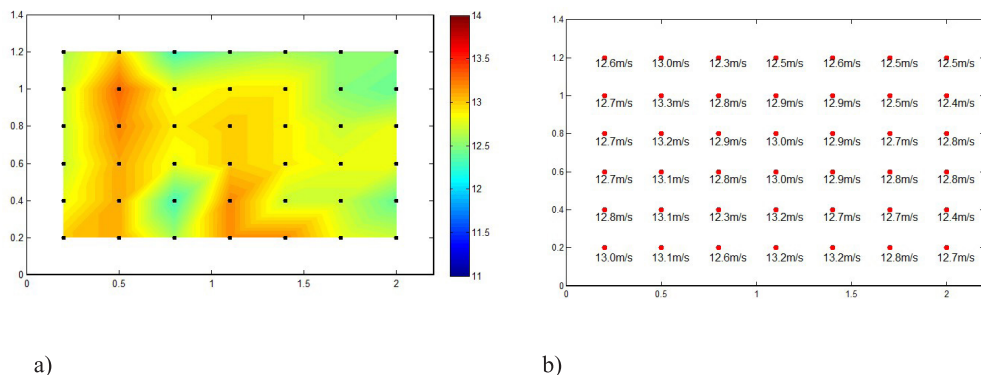
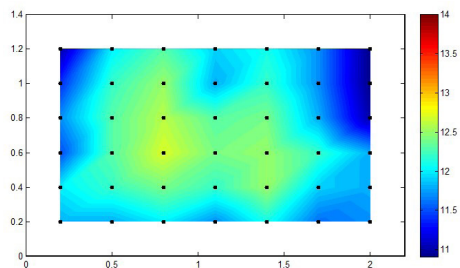

Fig. 11. Distribution of the mean wind velocity [m/s] at the inlet to the working section (after installing the guide vanes): 2D distribution (a), velocity values in the measurement points (b)

### 4.3. Measurements in the working section

Fig.12 presents results of the mean wind velocity distribution in 4<sup>th</sup> segment of the working section of the wind tunnel in the final state in the form of two-dimensional distribution (a) and velocity values in the measurement points (b). Additionally, a two-dimensional distribution of the mean wind velocity in two cross-sections of the wind tunnel space (inlet to the working section, 4<sup>th</sup> segment of the working section) is also presented in Fig.12c.

The results show clearly that in the area where wind tunnel tests were carried out, the distribution of the mean wind velocity is uniform. Such situation takes place only in the case without turbulence elements. A simulation of e.g. urban terrain categories by using spires, barriers or blocks would provide a significantly different distribution of mean wind velocities in the working section of the wind tunnel to the presented results.



a)

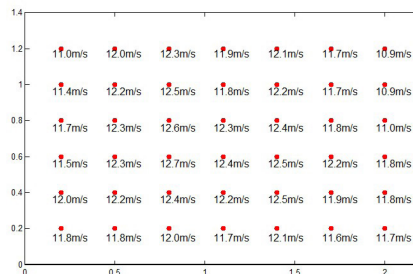

b)

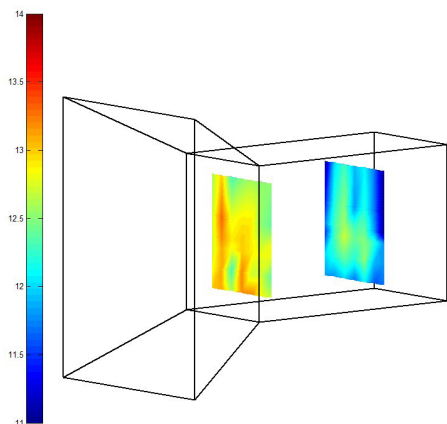

c)

Fig. 12. Distribution of the mean wind velocity [m/s] in the working section (after installing the guide vanes): 2D distribution (a), velocity values in the measurement points (b), 2D distribution in the view of the whole tunnel space (c)

#### 4.4. Selected cases of the guide vanes settings

In this section some measurement results which finally led to the proper guide vane arrangement and the uniform mean velocity distribution are presented. They were chosen to show the influence of guide vane angle of inclination on this distribution. Only the results of the measurements carried out at the inlet to the wind tunnel are presented.

Six measurement situations discussed further are summarized in Tab.1. Specific guide vane arrangement are assigned to the case (I-VI). Each of the guide vanes (1-10) has its own angle of inclination.

Table 1. Measurement cases of different guide vanes arrangements

Case	Guide vane number									
	1	2	3	4	5	6	7	8	9	10
	Inclination angle [°]									
<b>I</b>	76	76	76	67	74	71	57	49	50	39
<b>II</b>	76	76	76	67	74	71	57	49	50	68

<b>III</b>	111	113	96	102	94	80	91	86	85	69
<b>IV</b>	111	113	103	113	106	115	110	110	118	128
<b>V</b>	94	95	103	113	106	92	91	86	85	69
<b>VI</b>	111	113	103	113	106	92	91	86	85	69

Results of the measurements in the form as before – 2D distribution of the mean wind velocity, the mean wind velocity values in particular points in the cross-section at the inlet to the wind tunnel and guide vanes configuration corresponding to the specific case are shown in Figs 13–18.

### Case I

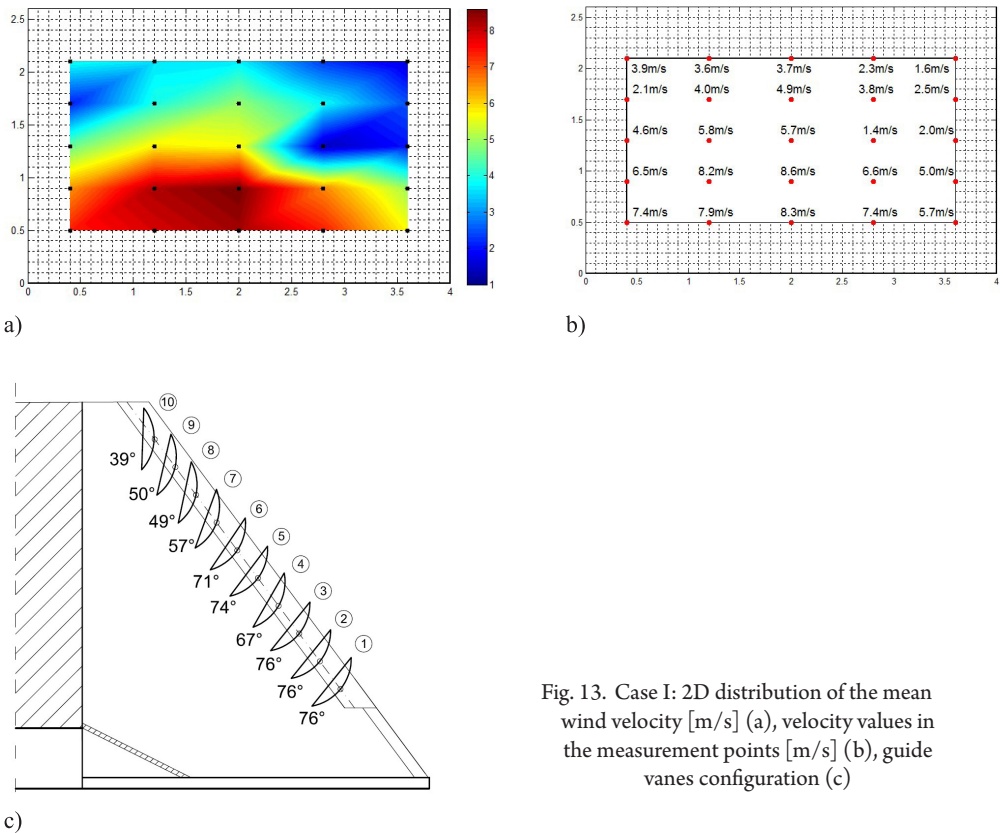

Fig. 13. Case I: 2D distribution of the mean wind velocity [m/s] (a), velocity values in the measurement points [m/s] (b), guide vanes configuration (c)

In the case I, high mean wind velocities (6–8 m/s) at the bottom and low (2–4 m/s) at the top of the measurement area can be observed. It was considered whether the 10<sup>th</sup> guide vane may block air flow in the higher part, which could cause a decrease in velocity. Due to this fact it was decided to increase the inclination of 10<sup>th</sup> guide vane.

## Case II

Inclination of 10<sup>th</sup> guide vane was increased while the angle of other guide vanes were as in Case I (Fig. 14). In this situation an increase in mean wind velocities at the top of the measurement area in comparison to Case I can be observed. It can be deduced that the change of the inclination angle of the guide vane enabled flow of the air stream into the inlet area. The inner side of the 10<sup>th</sup> guide vane directed it into the top part of the inlet to the wind tunnel.

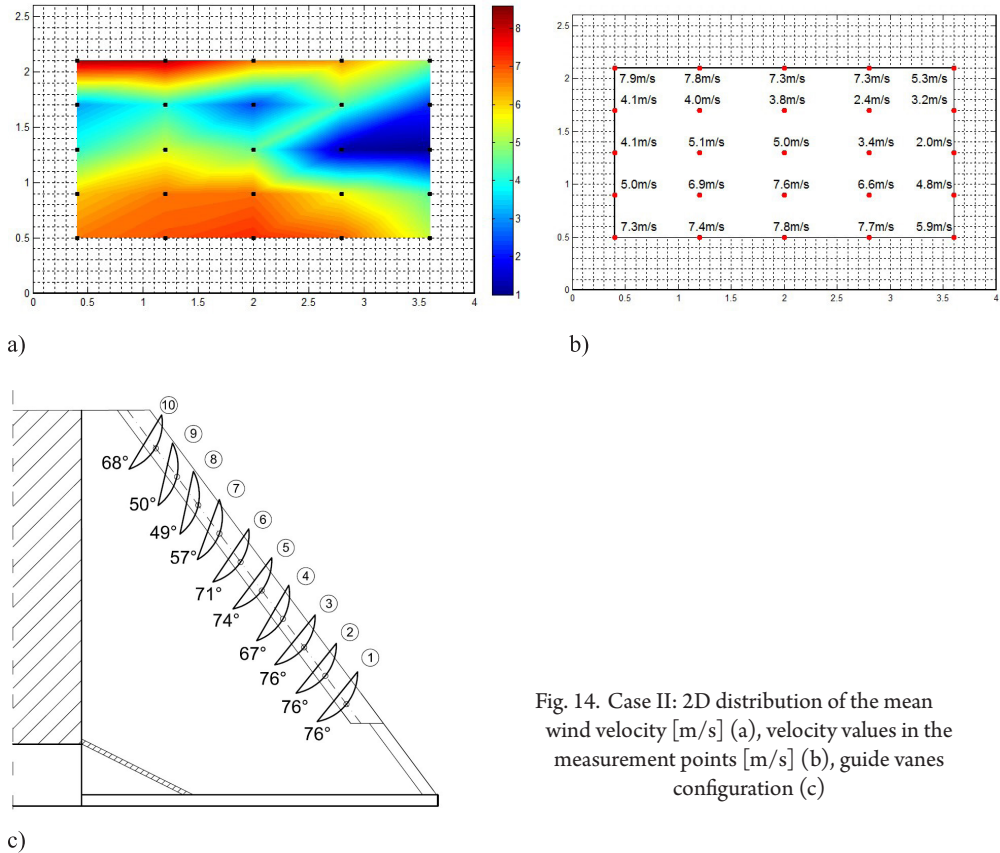

Fig. 14. Case II: 2D distribution of the mean wind velocity [m/s] (a), velocity values in the measurement points [m/s] (b), guide vanes configuration (c)

The influence of the change of each guide vane angle on the mean wind velocity distribution was also investigated during wind tunnel tests. Investigations were carried out in the following way: the angle of only one guide vane was changed while other guide vanes were in configuration as in case I. It should be noted that the change of the angle of one guide vane has a negligible influence on velocity distribution at the inlet space to the wind tunnel. However, the results of these cases are not presented in this paper.

### Case III

The inclinations of guide vanes 1–9 were increased while the angle of the 10<sup>th</sup> guide vane was as in Case II (Fig. 15). The significant change in guide vanes inclination angles caused improvement of the uniformity of the mean wind velocity distribution. Only at the top part of the inlet area on the left and the right side are the velocities lower (2–4 m/s).

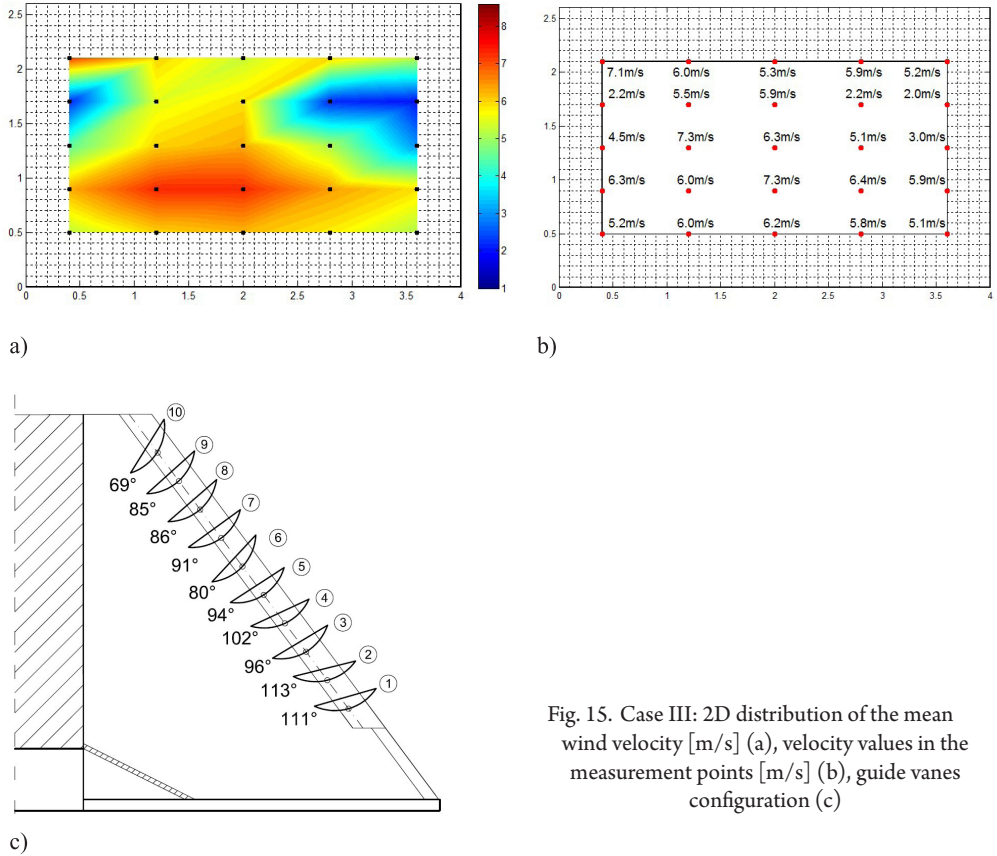

Fig. 15. Case III: 2D distribution of the mean wind velocity [m/s] (a), velocity values in the measurement points [m/s] (b), guide vanes configuration (c)

The reason could be quite obvious – the inlet area of the wind tunnel is not built over on the left and right side (comp. Fig. 4). The air can inflow to this empty space if it is not properly directed into the space of the wind tunnel. Due to this fact it was decided to use temporary partition foils aimed at limiting the area of air flow.

### Case IV

The inclination angles of guide vanes 3–10 were increased. Additionally, temporary partition foils were used over the height of the guide vanes set, starting from 0.5 m above floor level. These partition foils are marked in Fig. 16(c) as a dashed area.

These changes made an improvement in the uniformity of the mean wind velocity distribution. Regions of low wind velocity do not appear on both sides of the inlet area. There is only a slight difference in the velocities in the corners of the tested cross-section.

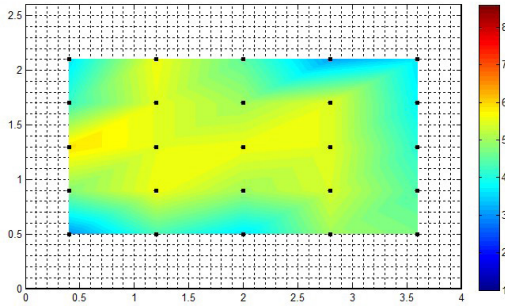

a)

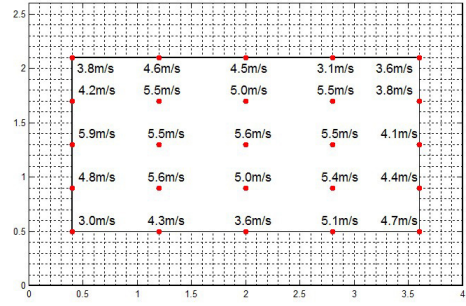

b)

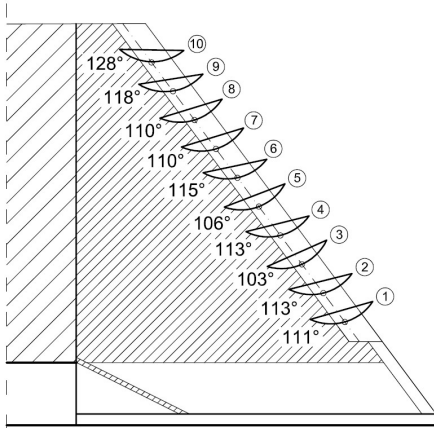

c)

Fig. 16. Case IV: 2D distribution of the mean wind velocity [m/s] (a), velocity values in the measurement points [m/s] (b), guide vanes configuration (c)

## Case V

In this arrangement inclination angles of upper guide vanes (6–10) and lower guide vanes (1–2) (Fig. 17) were decreased.

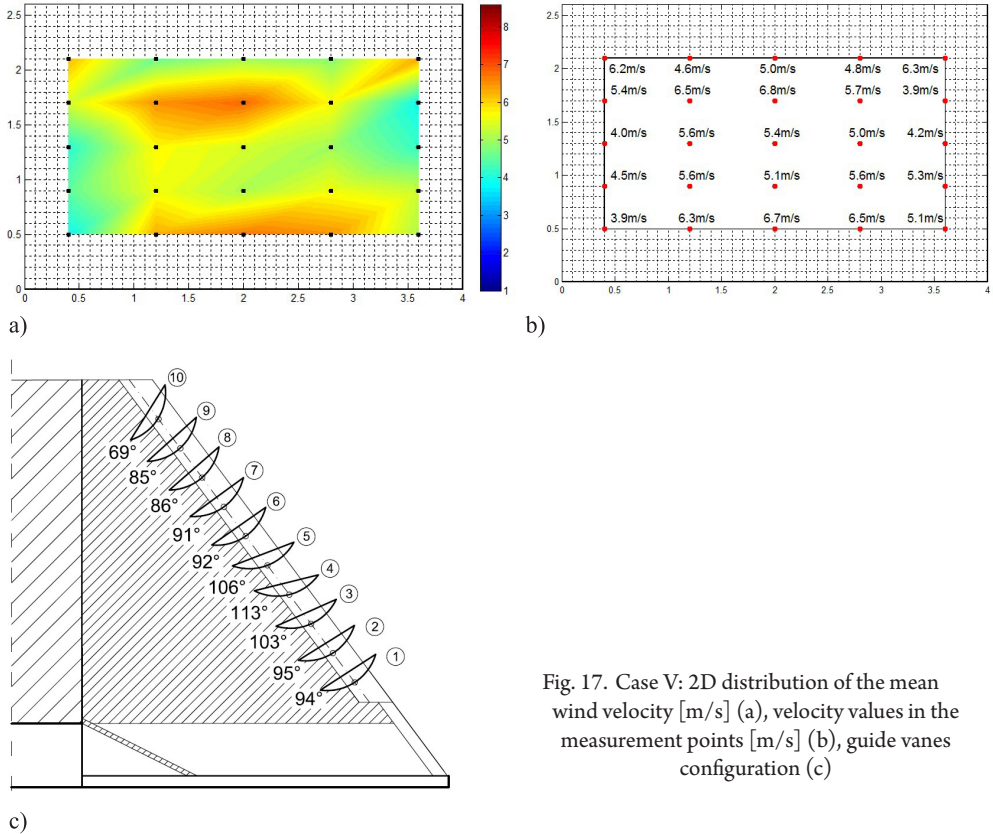

Fig. 17. Case V: 2D distribution of the mean wind velocity [m/s] (a), velocity values in the measurement points [m/s] (b), guide vanes configuration (c)

The improvement in the results in this case can be observed. The mean wind velocity in the corners of the wind tunnel inlet area is higher than in Case IV. Only the value in the left bottom corner is still slightly different to that in other measurement points.

## Case VI

The inclination angles of the lower guide vanes (1–2) were increased (as in Case IV) (Fig. 18). The improvement in uniformity of the mean wind velocity distribution was achieved by an increase in the inclination angles of the lower guide vanes and a decrease in the inclination angles of the upper guide vanes (in comparison to Case IV).

It should be highlighted that the upper guide vanes influence the mean velocity distribution at the top level of the wind tunnel inlet area as well as at the bottom level, because the air stream is directed by their inner and outer sides in different ways.

The results presented in Case VI were obtained for the situation using partition foils. It was only a temporary solution which was used to determine the best guide vane arrangement. The results of the mean wind velocity distribution in the wind tunnel inlet area for this guide vanes arrangement but without foils was presented in Fig. 8.

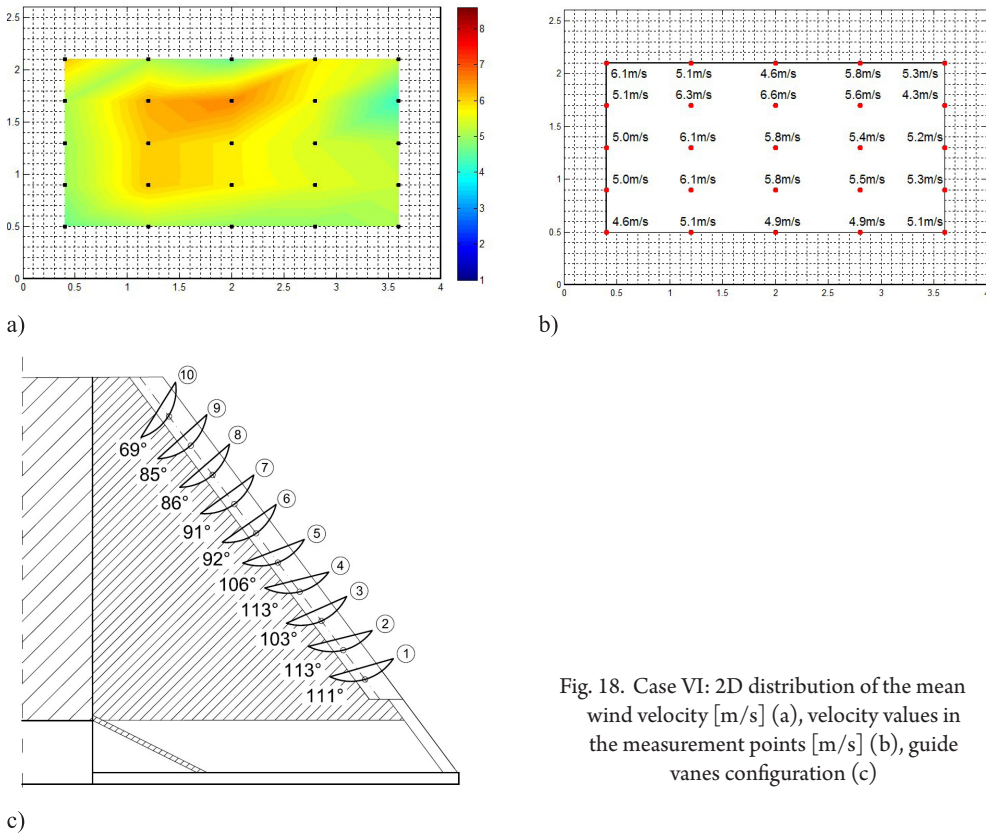

Fig. 18. Case VI: 2D distribution of the mean wind velocity [m/s] (a), velocity values in the measurement points [m/s] (b), guide vanes configuration (c)



## 5. Conclusions

The optimum setting of the guide vanes (Case VI) was applied as the final solution, but without the partition foils. In this arrangement both sides of the guide vanes – inner and outer – take part in directing the air stream into the inlet area of the wind tunnel. This setting leads to obtaining a uniform mean wind velocity distribution, which was the aim of these tests.

Experiments show that one set of guide vanes is a good solution for obtaining a uniform distribution of the wind velocity at the inlet to the wind tunnel. Especially, it is very useful solution for tunnels where there is insufficient space to apply other types of constructions. The specific arrangement of guide vanes provides uniform wind flow in its inlet section. Then wind conditions can be modified optionally in the working section.

## References

- [1] Cermak J.E., *Wind-tunnel development and trends in applications to civil engineering*, Journal of Wind Engineering and Industrial Aerodynamics 91, 2003, 355–370.
- [2] PN-EN 1991-1-4: Oddziaływania na konstrukcje. Oddziaływania ogólne. Oddziaływania wiatru.
- [3] PN-77/B-02011: Obciążenia w obliczeniach statycznych. Obciążenie wiatrem.
- [4] Flaga A., *Inżynieria wiatrowa. Podstawy i zastosowania*, Arkady, 2008.
- [5] Moonen P., Blocken B., Carmeliet J., *Indicators for the evaluation of wind tunnel test section flow quality and application to a numerical close-circuit wind tunnel*, Journal of Wind Engineering and Industrial Aerodynamics 95, 2007, 1289–1314.
- [6] Fang F.-M., Chen J.C., Hong Y.T., *Experimental and analytical evaluation of flow in a square-to-square wind tunnel contraction*, Journal of Wind Engineering and Industrial Aerodynamics 89, 2001, 247–262.
- [7] Abdelhamed A.S., Yassen Y.El-S., ElSakka M.M., *Design optimization of three dimensional geometry of wind tunnel contraction*, Ain Shams Engineering Journal 6, 2015, 281–288.
- [8] Doolan C., Morgans R., *Numerical Evaluation and Optimization of Low Speed Wind Tunnel Contractions*, 18th AIAA Computational Fluid Dynamics Conference, 25–28 June 2007, Miami, FL.
- [9] Moonen P., Blocken B., Roels S., Carmeliet J., *Numerical modeling of the low conditions in a closed-circuit low speed wind tunnel*, Journal of Wind Engineering and Industrial Aerodynamics 94, 2006, 699–723.
- [10] Scotto di Perta E., Agizza M.A., Sorrentino G., Boccia L., Pindozzi S., *Study of aerodynamic performances of different wind tunnel configurations and air inlet velocities, using computational fluid dynamics (CFD)*, Computers and Electronics in Agriculture 125, 2016, 137–148.
- [11] Atieh A., Al Shariff S., Ahmed N., *Novel wind tunnel*, Sustainable Cities and Society 25, 2016, 102–107.

- [12] Chen T.Y., Liou L.R., *Blockage corrections in wind tunnel tests of small horizontal-axis wind turbines*, Experimental Thermal and Fluid Science 35, 2011, 565–569.
- [13] Amrouche N., Dizene R., Laneville A., *Observations of the wind tunnel blockage effects on the mean pressure distributions around rectangular prisms in smooth and grid turbulent flows*, Revue des Energies Renouvelables SMEE'10 Bou Ismail Tipaza, 2010, 21–26.
- [14] Antoine J., Olivari D., Portugaels D., *Drag coefficient determination of bluff bodies – analysis of blockage effect*, COST Action C14, Impact of Wind and Storm on City Life and Building Environment, May 5-8 2004, Rhode Saint Genese, Belgium.