

KONRAD WEINREB, MACIEJ SUŁOWICZ, JANUSZ PETRYNA\*

## FAULTS DETECTION IN CAGE INDUCTION MOTOR WITH PARALLEL BRANCHES

### WYKRYWANIE USZKODZEŃ W SILNIKU INDUKCYJNYM KLATKOWYM Z GAŁĘZIAMI RÓWNOLEGLYMI

#### Abstract

The subject of the study is to analyze the effectiveness of early detection of damage to the stator winding with two parallel branches in the cage induction motor, by evaluating changes in the waveforms of branch currents in steady state operation. Harmonic components of the Fourier spectrum of circulating current, defined as the difference between the transient values of currents in the branches of the winding, were adopted as the indicators of branch current change evaluation. For a given low-power motor, several cases of a section short-circuiting in one of the winding branches were examined, for both symmetric and asymmetric air gap and for resistive symmetry and asymmetry of the rotor cage. The studies show a greater influence of damages on the changes in the amplitudes of selected harmonics of the circulating current, in comparison to changes of the stator phase current corresponding harmonics.

*Keywords: induction motor, stator winding with parallel branches, fault detection, circulating current*

#### Streszczenie

Przedmiotem artykułu jest analiza efektywności wykrywania uszkodzeń wewnętrznych w silniku indukcyjnym klatkowym z dwiema gałęziami równoległymi uzwojenia stojana, przez ocenę zmian w przebiegach prądów gałęziowych w ustalonym stanie pracy. Za wskaźniki oceny zostały przyjęte harmoniczne widma Fouriera prądu cyrkulacyjnego, zdefiniowanego jako różnica wartości chwilowych prądów w gałęziach uzwojenia. Dla silnika małej mocy zbadano przypadki zwarcia części jednej z gałęzi uzwojenia dla symetrycznej oraz niesymetrycznej szczeliny powietrznej oraz symetrycznej i niesymetrycznej rezystancyjnie klatki wirnika. Wykazano większy wpływ uszkodzenia na zmiany amplitud wybranych harmonicznych prądu cyrkulacyjnego, w porównaniu do zmian analogicznych harmonicznych prądu fazowego stojana.

*Słowa kluczowe: silnik indukcyjny, uzwojenie stojana z gałęziami równoległymi, wykrywanie uszkodzenia, prąd cyrkulacyjny*

\* D.Sc. Ph.D. Eng. Konrad Weinreb, Ph.D. Eng. Maciej Sułowicz, Ph.D. Eng. Janusz Petryna, Institute of Electromechanical Energy Conversion, Faculty of Electrical and Computer Engineering, Cracow University of Technology.

## 1. Introduction

Damages to the AC machine windings: broken phases, short circuits and the resulting elimination of winding parts, are a serious problem both in the operation and diagnostics of machines. Due to the small, almost imperceptible changes in the rms of phase currents in the event of a short circuit of small number of turns in the stator winding, conventional protection systems cannot turn off the machine. The range of damage can enlarge rapidly, leading to a major accident eliminating the drive from operation. Similarly, the fault diagnosis based only on the phase currents in the steady state (spectral analysis) is not effective.

In [1], a concept was introduced of the use of angular displacement between the stator phase currents of the induction motor for inter-turn shorts detection, allowing to determine both the extent of damage, as well as its location, confirmed by laboratory tests.

The above [1] promoted the utility of assessment of changes in the amplitude of the stator current negative sequence with increasing of the degree of damage to the windings for the purpose of diagnostics.

Several cases of co-occurrence of different asymmetries and damages of AC machines (broken rotor bars, eccentricities, inter-turn and inter-phase short circuits) and methods of effective diagnosis in the example of a motor with parallel branches are presented in [2]. High-power motors with parallel branches are often used in different drives in power and general industry due to their characteristics and improved reliability. In this paper, a discrete wavelet analysis (DWT – Discrete Wavelet Transform) was used to examine the motor transient current during the start-up. The ways to use knowledge of the phase and branch currents in diagnosing particular combinations of simultaneously occurring damages are presented. The use of this method in industrial conditions is possible if the current transformers or sensors can be installed inside or outside the machine.

The work [3] points the opportunities offered by the use of the circulating current flow between parallel branches of a synchronous motor stator in the early stages of static, dynamic and mixed eccentricity development, for the diagnosis. The work [3] proves, based on simulation and laboratory tests, a greater suitability of the circulating current than a branch one, for detecting damages.

Another method for detecting faults in stators windings is presented in article [4]. A simple measurement of the unipolar flux using a coil installed around the motor shaft or on end windings provides immediate detection of inter-turn fault even at 1 shorted coil turn. The measurement signal indicating a short circuit is several times greater than for the symmetry and its amplitude order are volts. It can be applied to a quick-response protection system.

In the article, a method will be analyzed, which improves the effectiveness of the detection and assessment of the degree of stator winding damage, based on an analysis of selected harmonic changes in the phase current as well as in the circulating current, defined by [3] as the difference of the transient values of currents in parallel branches. Based on the measurements for a low-voltage low-power motor, the results of analyzes of selected cases of damage, which were preset in advance, will be presented. The features of the current spectrum, clearly showing the type of damage to the rotor, will be identified.

## 2. The method of diagnosing and measuring system

The object of the analyzes and laboratory tests presented in this article was the motor SZJKe14a of the following data:  $P_N = 0.8$  kW,  $U_N = 380$  V(Y),  $I_N = 2.2$  A,  $n_N = 1400$  rpm and the number of stator slots  $N_s = 24$  and rotor bars  $N_r = 22$ . This motor is a type “2”, of the  $g$  parameter = 2 – [5–7].

The motor, powered by stator windings connection reduced to half the rated voltage at the start, with two parallel branches in every phase, worked at the rated speed, loaded by an eddy current brake. The motor had 2 replaceable rotors: one with the symmetrical cage and the other with 2 broken bars. The winding of the induction motor stator under test consists of 12 coils, 4 coils per phase and of a single-layer, basket – execution winding. The winding of the total number of slots per pole and phase produces a flux, which harmonics are odd multiples of the number of magnetic poles pairs  $p$ .

Evaluation of damage to the stator winding, rotor cage and the air gap is based on the analysis of changes in the amplitudes of selected harmonics of stator phase currents and parallel branch current spectra, describing the violation of the symmetry of these circuits. From among a multiplicity of current harmonics observed in the spectrum, for the needs of the motor diagnostics evaluation, only four harmonics were selected [6, 7]:

- supply frequency  $f_0$  (1)
- slip harmonics, their frequencies are associated with slip  $s$ , including:
  - the harmonic, indicating a rotor cage damage or dynamic eccentricity appearance

$$f_{\text{dyn}} = (1 - 2s)f_0 \quad (2)$$

- harmonics, indicating the simultaneous occurrence of several types of asymmetry

$$f_{\text{mix}} = f_0 \pm f_r \quad (3)$$

where:

$$f_r = n/60 - \text{rotor frequency.}$$

Fig. 1 shows a view of the stator winding lead panel on which the windings were configured in an appropriate way.

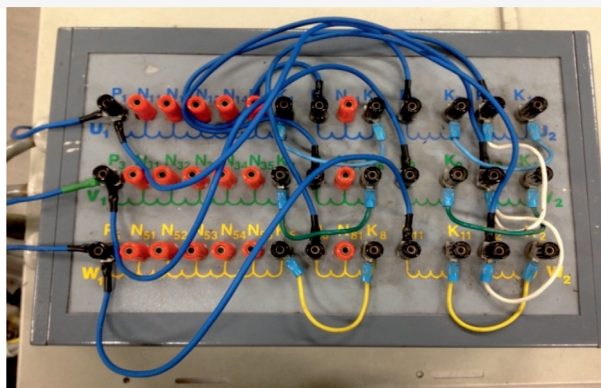

Fig. 1. Stator windings configuration panel

In the case of a short circuit test of a coil section, a short-circuit current of a nominal value of the phase current was kept flowing through the attached external resistor with adjustable resistance. The wiring diagram is shown in Fig. 2.

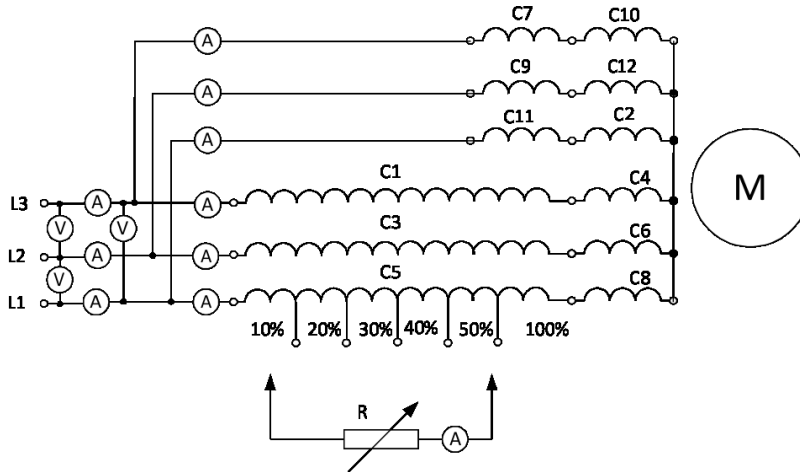

Fig. 2. The wiring diagram of the measuring system

Nine LEM HY-15 current transducers were used to measure the current, while three LV-25 voltage transducers were used to measure the voltage. The signals from current and voltage transducers were transmitted to the analog input measurement card NI USB 6259 BNC. All the twelve signals were recorded in 10 seconds time with use of the signal acquisition software prepared in Matlab with a sampling frequency of 20 kHz.

### 3. Results of measurements and measuring data analysis

The figures below show the spectra of phase and circulating currents in three stator winding phases in the frequency range of 0–150 Hz, obtained on the basis of measurements for selected cases of the motor faults.

A comparison was conducted of the spectrum for the symmetry of the motor with the spectra for the following cases:

- 30% of turns shorted in a coil in phase U parallel branch what means 15% of turns shorted in the parallel branch and 7.5% of turns shorted in the phase of the winding;
- two adjacent bars of the rotor cage broken;
- 20% air-gap static eccentricity.

The evaluation of changes in the amplitudes of the four selected above current spectrum harmonics, arising under the influence of a selected damage as well as of several simultaneous failures, was carried out.

For each analyzed case, the rms values of the current harmonics are given in mAmps. All the measurements were carried out for the same rotor speed  $n = 1400$  rpm.

The presented range of the spectrum frequency includes a basic harmonic and – in order to distinguish – harmonics of frequencies specific for a damaged cage:  $f_0(1-2s) = 43.3$  Hz, and for a mixed eccentricity:  $f_0 - f_r = 26.7$  Hz and  $f_0 + f_r = 73.3$  Hz.

The study of the influence of a given asymmetry on a change of the analyzed current spectra is facilitated by setting-up the rms values of selected harmonics of phase currents and circulating currents, presented for different cases in separate tables.

Changes in the current harmonics magnitudes, which are essential for diagnostic evaluation, are highlighted in bold.

### 3.1. Cases of stator winding symmetry and short circuit of a part of the coil turns in a parallel branch at symmetrical air-gap and symmetrical rotor cage

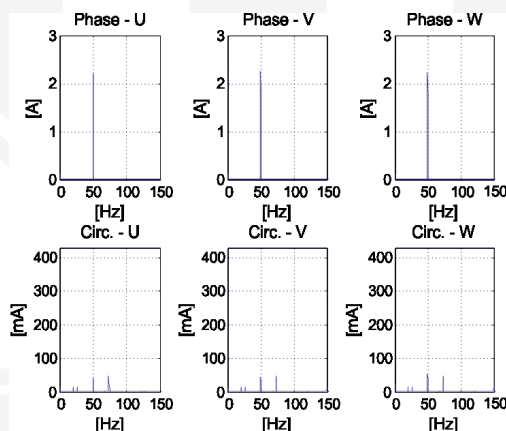

Fig. 3. Harmonics of phase currents [A] (row above) and circulating currents [mA] (row below) – symmetrical machine

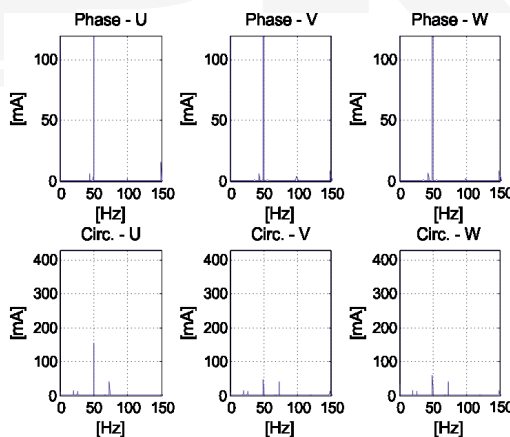

Fig. 4. Harmonics of phase currents [mA] (row above) and circulating currents [mA] (row below) – 30% of turns in the coil of the stator winding shorted

Table 1

Summary of the rms values of the stator phase current harmonics and the circulating current harmonics for the cases of symmetry and shorted turns in the coil

$f_{\text{har}}$ [Hz]	Rms values of the stator current harmonics [mA]											
	Symmetrical machine						30% shorted turns in the stator coil					
	Phase current			Circulating current			Phase current			Circulating current		
	$U$	$V$	$W$	$U$	$V$	$W$	$U$	$V$	$W$	$U$	$V$	$W$
26.7	0	0	0	15	15	15	1	0	0	10	10	10
43.3	7	6	6	0	0	0	6	6	6	0	0	0
50	2220	2250	2240	4	4	5	2150	2080	2090	<b>157</b>	<b>47</b>	<b>57</b>
73.3	1	0	0	47	47	46	0	0	0	41	41	41

The analysis of changes in the amplitudes of the current harmonics shown in Table 1 leads to the following observations:

- in the spectra of the phase currents, the short circuit caused a slight variation of effective values of the fundamental harmonic only;
- in the spectra of the circulating currents, the short circuit caused a significant increase and diversification of the effective values of the fundamental harmonic – the largest increase in the damaged phase.

### 3.2. Cases of stator winding symmetry and short circuit of a part of the coil turns at symmetrical air-gap and two broken bars of the rotor cage

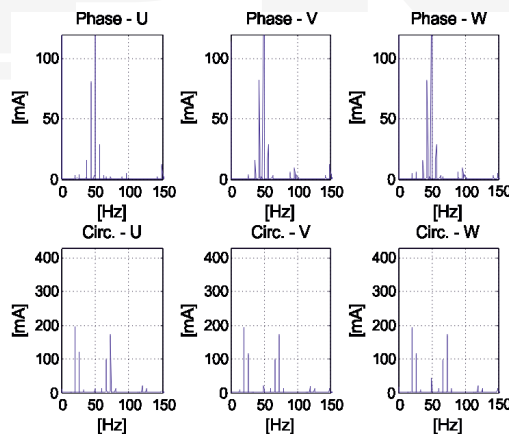

Fig. 5. Harmonics of the phase and circulation currents [mA] – case of air-gap symmetry and 2 broken bars and symmetrical stator winding

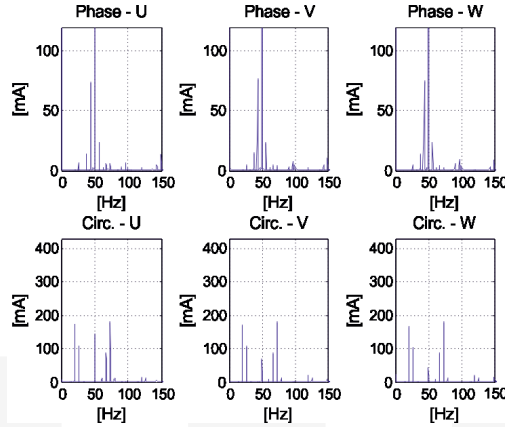

Fig. 6. Harmonics of the phase and circulation currents [mA] – case of air-gap symmetry and 2 broken bars and 30% of shorted turns in the stator phase winding coil

Table 2

Summary of the rms values of the stator phase current harmonics and the circulating current harmonics for cases: symmetry and 30% shorted turns in the coil

$f_{\text{har}}$ [Hz]	Rms values of the stator current harmonics [mA]											
	2 broken bars of the rotor cage						2 broken bars of the rotor cage and 30% shorted turns in the U phase coil					
	Phase current			Circulating current			Phase current			Circulating current		
	<i>U</i>	<i>V</i>	<i>W</i>	<i>U</i>	<i>V</i>	<i>W</i>	<i>U</i>	<i>V</i>	<i>W</i>	<i>U</i>	<i>V</i>	<i>W</i>
26.7	4	4	6	119	117	117	4	5	5	108	106	104
43.3	81	82	82	2	4	2	74	77	75	2	4	2
50	2180	2200	2160	10	20	40	2200	2140	2140	146	67	41
73.3	2	1	0	174	174	175	5	4	2	179	181	182

As a result of the rotor cage asymmetry (two adjacent bars broken) compared to the symmetry of the motor, the rms values of the harmonic components of frequencies (among others) as:

- $f_0(1-2s) = 43.3$  Hz in the phase current spectrum,
- $f_0 - f_r = 26.7$  Hz and  $f_0 + f_r = 73.3$  Hz in the circulating current spectrum, significantly increase.

Changes in the values of these harmonics are the same in each phase of the winding, which confirms the effectiveness of the commonly used method for detecting the rotor cage damage based on monitoring the current of only one stator phase.

Similarly as in the previous case 3.1, as a result of a short circuit, the value of the basic harmonic of the circulation current has significantly increased in the damaged phase of the stator winding.

It should be stressed that both asymmetries change the values of the other current harmonics of the spectrum independently, which makes it possible to distinguish the type of damage.

### 3.3. Cases of stator winding symmetry and short circuit of part of the coil turns at a static eccentricity

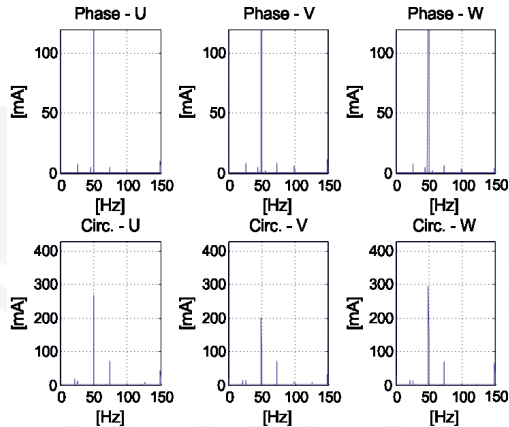

Fig. 7. Harmonics of the phase and circulation currents [mA] – case of 30% static eccentricity and symmetrical stator winding

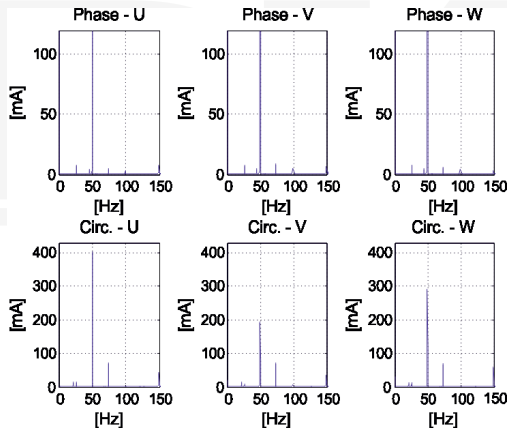

Fig. 8. Harmonics of the phase and circulation currents [mA] – case of 30% static eccentricity and 30% of shorted turns in the stator phase winding coil

Detection of static eccentricity based on the analysis of changes in phase current harmonics in the presented frequency range is practically impossible. One of the possible solutions to the task is to transform the currents into symmetrical components and assess



the growth of the opposite component of the basic current harmonic. Analyzing the basic harmonic of the circulation current removes this inconvenience.

The results of measurements shown in Table 3 indicate that a small static eccentricity adopted in the experiment causes a similar spectacular rise in the value of that harmonic in each phase of the winding.

Table 3

**Summary of the rms values of the stator phase current harmonics and the circulating current harmonics for cases: symmetry and 30% shorted turns in the coil**

$f_{\text{har}}$ [Hz]	Rms values of the stator current harmonics [mA]											
	30% static eccentricity						30% static eccentricity and 30% shorted turns in the U phase coil					
	Phase current			Circulating current			Phase current			Circulating current		
	<i>U</i>	<i>V</i>	<i>W</i>	<i>U</i>	<i>V</i>	<i>W</i>	<i>U</i>	<i>V</i>	<i>W</i>	<i>U</i>	<i>V</i>	<i>W</i>
26.7	7	8	8	12	13	11	7	8	8	14	9	12
43.3	5	5	5	0	0	0	4	6	3	0	0	0
50	2040	2070	2050	<b>269</b>	<b>204</b>	<b>295</b>	2000	1930	1960	<b>402</b>	<b>192</b>	<b>292</b>
73.3	5	8	7	71	73	69	4	8	6	72	73	69

Damage to a phase of the winding results in an additional significant increase in the amplitude of the fundamental harmonic of the circulation current in this phase. This means that there is a possibility of detecting the asymmetries and distinguishing the between the two types.

#### 3.4. Cases of stator winding symmetry and short circuit of part of the coil turns in a parallel branch at a static eccentricity and two broken bars of the rotor cage

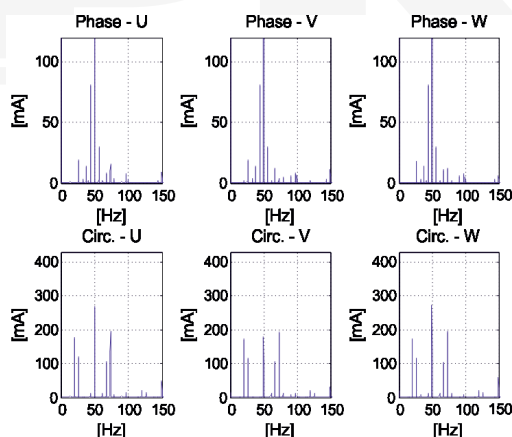

Fig. 9. Harmonics of the phase and circulation currents [mA] – case of 30% static eccentricity and 2 broken bars of the rotor cage and symmetrical stator winding

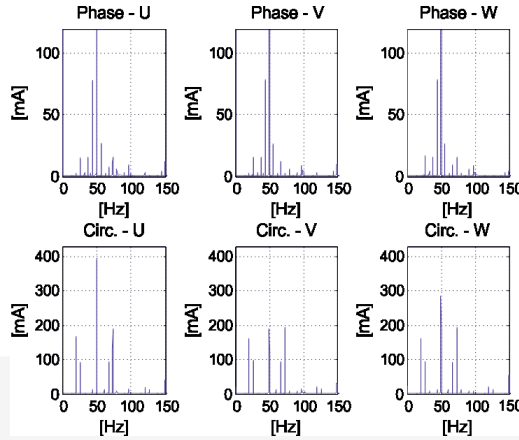

Fig. 10. Harmonics of the phase and circulation currents [mA] – case of 30% static eccentricity and 2 broken bars of the rotor cage and 30% of shorted turns in the coil of the stator phase winding

Table 4

Summary of the rms values of the stator phase current harmonics and the circulating current harmonics for cases: symmetry and 30% shorted turns in the coil

$f_{\text{har}}$ [Hz]	Rms values of the stator current harmonics [mA]											
	30% static eccentricity, 2 broken bars						30% static eccentricity, 2 broken bars and 30% shorted turns in the U phase coil					
	Phase current			Circulating current			Phase current			Circulating current		
	U	V	W	U	V	W	U	V	W	U	V	W
26.7	19	19	19	118	117	117	14	15	17	91	97	95
43.3	82	81	81	12	6	10	78	79	78	12	5	11
50	2220	2240	2210	268	181	273	2170	2110	2200	394	189	286
73.3	15	4	12	196	192	194	15	2	15	190	191	192

The spectra of the phase and circulation currents presented in this section, and effective values of the analyzed current harmonics summarized in Tab. 4, concern the cases of simultaneous occurrence of all typical defects to a cage induction motor, mentioned in this article.

Evaluation of changes in the marked out current harmonics leads to a significant (for the diagnosis of machine condition) conclusion that any kind of damage changes the values of the current harmonics distinctively and independently of the other damages.

It should be stressed that there is a greater sensitivity of the circulating current harmonics in comparison with the harmonics of the phase currents, to damages (higher changes of values).

#### 4. Summary

The paper presents the results of analysis of the influence of the induction motor inner structural asymmetry, on the specific changes in amplitudes of phase and circulating current harmonics (differential currents in parallel branches) in these phases, caused by a damage.

The object of the study included the following cases: a part of the turns short circuit the coil in the parallel branch of the stator phase winding, broken bars in the rotor cage and static eccentricity. These damages were implemented separately or jointly in various configurations. Evaluation of changes in the values of four selected current harmonics in each case was referred to the symmetrical motor.

The results of the measurements allow to conclude that it is possible to detect and distinguish those defects even at early stages. The application of the circulating current as an additional diagnostic signal significantly improves the efficiency of the motor condition diagnosis based on the phase current analysis, and in many cases of damages is even indispensable. The research has confirmed that, in the cases of the stator winding asymmetry or static eccentricity, only the assessment of changes in the amplitude of the circulating current harmonics, in all stator phases in the analyzed frequency range, enables a proper assessment of a damage. The two types of damage mentioned above noticeably differentiate small amplitudes of the phase current harmonics, not until the frequency of the so-called slot passing harmonics [8]. A measurement of the circulating currents allows to reduce the number of checked current harmonics whose amplitudes reach relatively large values and strongly depend on the damage to the harmonics close to the primary one.

#### Acknowledgment

*Presented results of the research, which was carried out under the theme No. E-2/581/2016/DS, was funded by the subsidies on science granted by Polish Ministry of Science and Higher Education.*

#### References

- [1] Wolkiewicz M., Kowalski Cz. T., *Nieinwazyjne metody wczesnego wykrywania zwarć zwojowych w silniku indukcyjnym zasilanym z przemiennika częstotliwości, cz. I*, Zeszyty Problemowe – Maszyny Elektryczne nr 87, wyd. BOBRME Komel, 2010, 145–150.
- [2] Antonino-Daviu J., Jover Rodriguez P., Riera-Guasp M., Pineda-Sa´nchez M., Arkkio A., *Detection of combined faults in induction machines with stator parallel branches through the DWT of the startup current*, Mechanical Systems and Signal Processing, 23, 2009, 2336–2351.
- [3] Rodriguez P., Rzeszucinski P., Sulowicz M. et al., *Stator circulating currents as media of fault detection in synchronous motors*, SDEMPED 2013, Proceedings, 207–214.

- [4] Petryna J., Sułowicz M., Duda A., Guziec K., *Wykorzystanie strumienia unipolarnego w diagnostyce maszyn prądu przemiennego*, Zeszyty Problemowe – Maszyny Elektryczne Nr 2/2013 (99), wyd. BOBRME Komel, 85–90.
- [5] Weinreb K., Węgiel T., Sułowicz M., *Wpływ wewnętrznych niesymetrii w silniku asynchronicznym klatkowym na własności widma prądu stojana*, Przegląd Elektrotechniczny, nr 11, 2006, 80–83.
- [6] Weinreb K., Sułowicz M., *Skuteczne wykrywanie ekscentryczności dynamicznej w silniku asynchronicznym*, Zeszyty Problemowe – Maszyny Elektryczne nr 83, wyd. BOBRME Komel, 2009, 207–212.
- [7] Weinreb K., *Diagnostics of an Induction Motor Rotor by the Spectral Analysis of Stator Currents*, Thermal Engineering, Vol. 60, No. 14, 2013, 1006–1023.
- [8] Weinreb K., Sułowicz M., Petryna J., *Wykrywanie uszkodzeń uzwojenia stojana w silniku indukcyjnym klatkowym z gałęziami równoległymi*, Zeszyty Problemowe – Maszyny Elektryczne nr 103, wyd. BOBRME Komel, 2014, 71–76.
- [9] Wan Shuting, Li Heming, Li Yonggang and Meng Fanchao, *Analysis of stator winding parallel-connected branches circulating current and its application in generator fault diagnosis*, Fourtieth IAS Annual Meeting. Conference Record of the 2005 Industry Applications Conference, Vol. 1, 2005, 42–45.

