

ANDRZEJ HERBST\*

## TWO CONSTRUCTIONS OF IE4 EFFICIENCY CLASS SYNCHRONOUS MOTORS WITH DISTRIBUTED AND CONCENTRATED WINDING

### DWIE KONSTRUKCJE SILNIKA SYNCHRONICZNEGO O SPRAWNOŚCI KLASY IE4: Z UZWOJENIEM ROZŁOŻONYM I SKUPIONYM

#### Abstract

This paper takes into consideration two PMSM motors of size 80 with very similar efficiency and output power. In the article, design differences between a classic 4 pole/24 tooth motor with distributed winding and a 10 pole/12 tooth motor with concentrated winding are shown. Calculations and tests results are also presented for both machines.

*Keywords: PMSM motor, distributed winding, concentrated winding*

#### Streszczenie

W artykule przedstawiono dwa silniki synchroniczne z magnesami trwałymi o wzniosie wału 80 mm z bardzo podobną sprawnością i mocą wyjściową. Artykuł skupia się na pokazaniu różnic między konstrukcjami silnika 4-biegunowego/24-żłobkowego z uzwojeniem rozłożonym a 10-polowego/12-żłobkowego z uzwojeniem skupionym. Przedstawiono również wyniki obliczeń oraz badań obu maszyn.

*Słowa kluczowe: silnik PMSM, uzwojenie rozłożone, uzwojenie skupione*

**DOI: 10.4467/2353737XCT.15.027.3827**

\* M.Sc. Eng. Andrzej Herbst, NORD GmbH, Germany.

## 1. Introduction

Due to many advantages of relatively small motors (up to 95% for 1.5 kW, 1500 rpm) such as the high efficiency possibilities, continuous operation without fan, supply by converter with sensorless algorithms and flat surface housing, synchronous motors with rare earths magnets are more and more common on the market. When we add the fact that the price of such a motor is similar to an IE3 asynchronous motor, a PMSM becomes the best choice for a variable speed drives. What is more, an IE4 PMSM motor can be one or two sizes smaller compared to IE3 asynchronous machines. Up until now, except for high performance servo motors, designers were utilizing standard lamination packages for synchronous motors – either PMSM or reluctance. This means that the cage rotor from classic, asynchronous motors was taken out and a new synchronous package was designed. This is an easy and cheap way to lead a quite good motor into production. Even without the optimal shape of stator, efficiency improvement is high enough to fulfil the new standard, e.g. higher IE class. Such an idea has one important advantage – the winding is also the same. No additional effort need be made to design the new winding technology. Usually, up to 3 kW, 1500 rpm motors consist of 4 poles. In the range of 3 up to 10 kW, 6 or 8 pole variants are also popular. It must be said that these machines are not optimized in order to minimize the amount of materials and maximize the power to weight factor. So the optimal shape of motor's cross section will vary from original asynchronous one.

## 2. Test objects and design software

This comparison takes as a base two synchronous motors with 0.75 kW power at a speed of 1500 RPM and an efficiency of 90%. In the described cases, both constructions have rotor with inserted magnets and sinusoidal EMF. Figure 1 shows a 4 pole example.

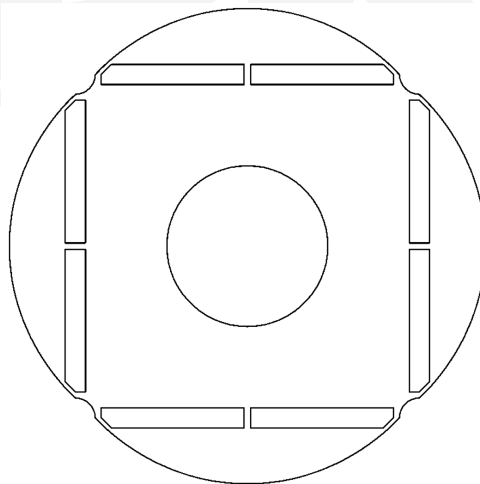

Fig. 1. Investigated 4 poles rotor geometry

Of course, this is one of several possible geometries [1], but with this inserted type, sinusoidal-pole is an internal, company standard. The construction has important advantages like ease of manufacturing the package and the magnet's assembly. Geometry of the stator as well as the winding is classic – like in 4 pole, 24 slot asynchronous motors, where  $q$  (number of slots per pole, per phase) is 2. For motor size 80, this is the most common case. It has the best ratio between material usage (weight) and efficiency (asynchronous machine). The second motor has similar rotor construction – see Fig. 2. Stator consists of 12 slots – which makes  $q$  equal to 0.4. This is shown in Fig. 3. For two layers winding (one coil for each tooth) winding factor is 0.933. A 10 pole, 12 tooth construction was chosen because it gives the best ratio between manufacturing costs, material usage, balanced magnetic pull and relatively low iron losses [2]. As low supply voltage frequency as 125 Hz at nominal speed is also an advantage for sensorless algorithms – processor of converter is fast enough to work with such a motor even at 3000 RPM (250 Hz). Where 400 Hz is a maximum frequency of an industrial standard. Let's look closer to the calculation's idea for both motors. Usually, worldwide there is one similar method to create universal software for designing efficient, material-saving motor in a short time.

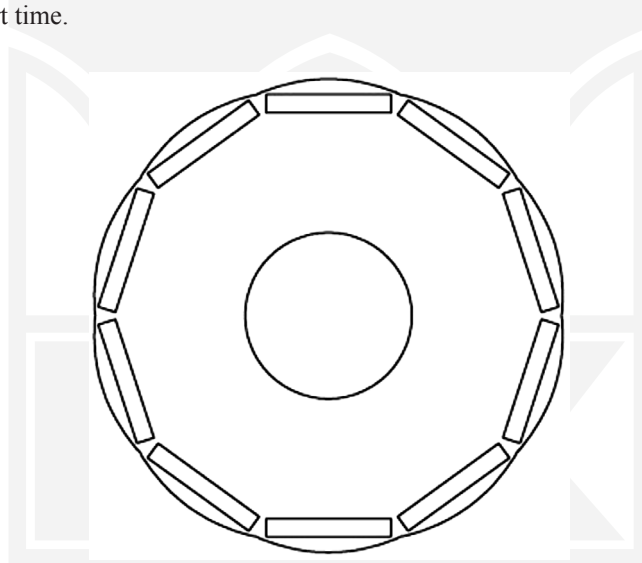

Fig. 2. Investigated 10 poles rotor geometry

The method is to combine mathematical language software with a program for finite-element calculations [3, 4]. Such a combination guarantees ease and high flexibility when changing the construction of the investigated model, such as the type of rotor or magnet material as well as the geometrical dimensions. The finite elements method (when well adjusted) shows great sensitivity when calculating cogging torque or the EMK. Nowadays, every synchronous motor should not only have a high efficiency factor but also a low THD of EMF, low cogging torque and low torque ripples. These help to achieve stable control of the frequency converter. Having already a few years of experience and reliable software, the designer can rely on it and omit the analytical method. In the software used for simulation, the problems are divided into two groups – cases with the current and without current.

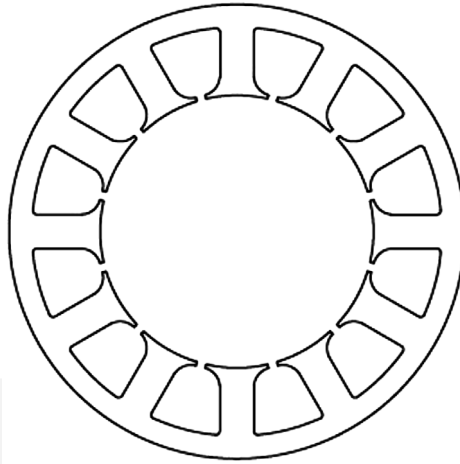

Fig. 3. Investigated 12 teeth stator geometry

In the first group, the user can investigate what follows: torque over angle characteristic (with DC currents in winding); normal torque characteristic + iron losses (AC currents in winding); inductance over angle characteristic (DC currents in winding) [5]. In the second group, two tests could be performed – cogging torque and EMF. A written script allows the user to choose which problem will be solved.

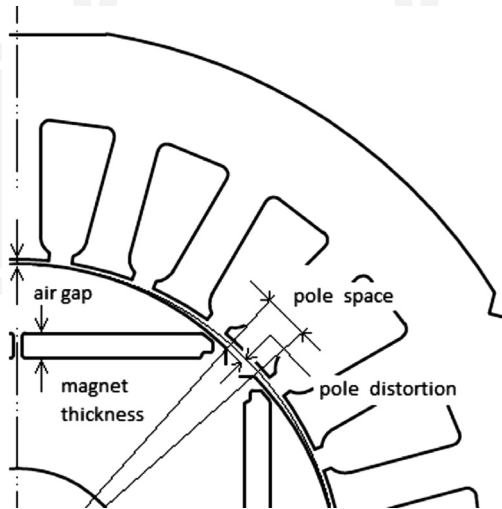

Fig. 4. Design variables of both rotors

Usually, all of them must be executed to check certain construction in a full aspect. As is mentioned above, in the case of 4 pole motors, only the rotor was optimized. The mechanical parameters which were a subject of the optimization of both rotors are shown in Fig. 4. The air gap, which is not a part of rotor, is also taken into consideration here.

In case of the 10 pole, 12 tooth motor, the next four parameters of stator were investigated: tooth wide; tooth high; joke high; slot enter gap. In the next part of the article, ranges of all the variables are shown.

### 3. Design results and tests results.

For the first rotor, Table 1 shows the range of investigation. Outside these ranges, some parameters from THD, cogging torque, average torque or torque ripples are poor. Such parameterisation makes the design process easier and faster. For all variables, vectors with possible values were created. The length of the stack, because of the standard for asynchronous motors, was kept at 60 mm.

Table 1

**Range of variables for 4 poles rotor**

Name of variable	Range of variable
Pole space [part of pole]	[0.06 : 0.005 : 0.09]
Magnet thickness [mm]	[2 2.5]
Air gap [mm]	[0.3 0.4 0.5 0.6]
Pole distortion [mm]	[1.3 : 0.1 : 1.7]

These ranges could look a little bit too narrow but it was found that such steps between values are precise enough to find final, optimized construction [6]. Previously, wider ranges of variables were also investigated with poorer mesh quality. The range of investigation of the second motor can be seen in Table 2. Also in this case, the ranges of some variables were cut. Wider ranges cause a longer calculation time because the number of construction rises very fast.

Table 2

**Range of variables for 10 poles rotor**

Name of variable	Range of variable
Pole space [part of pole]	[0.06 : 0.001 : 0.1]
Magnets thickness [mm]	[2 2.5]
Air gap [mm]	[0.3 0.4 0.5]
Pole distortion [mm]	[0.4 : 0.2 : 1]
Stator inner diam. [mm]	[60 : 1 : 72]
Stator's tooth wide [mm]	[7 : 1 : 12]
Stator's joke high [mm]	[5 : 1 : 8]
Slot entry gap [mm]	[2 : 0.2 : 3]

In the case of 10 pole, 12 tooth construction, the package length was not a variable but was adjusted (calculated) after the optimization process to achieve the requested efficiency. In the next figures, a comparison between fem simulations and real measurements for both motors is presented. Firstly, Figs. 5 and 6 show torque against angle curves.

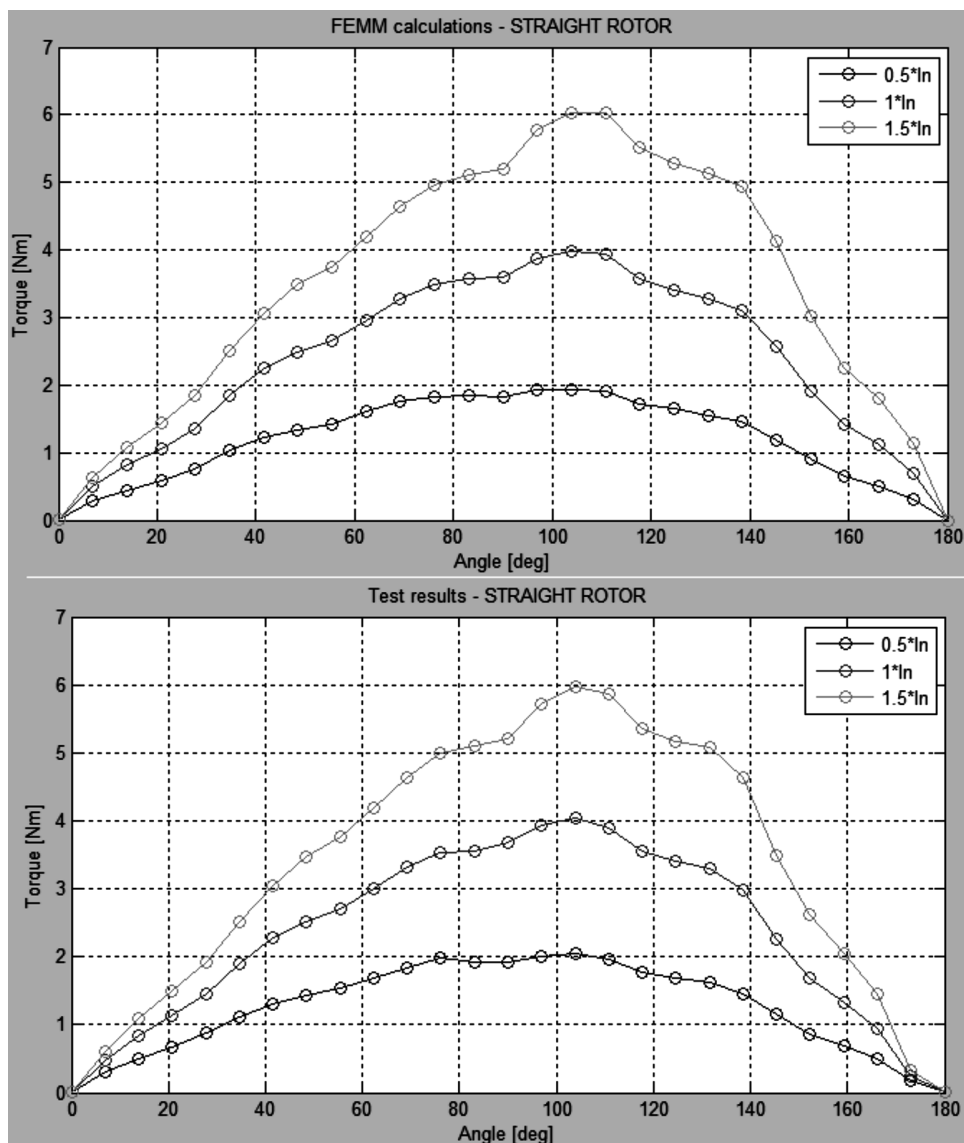

Fig. 5. Torque against angle, 4 poles (0.5xIn, In, 1.5xIn)

In this certain case, two phases were supplied with a DC current. During this test, the shaft was blocked and gradually turned with the help of a high ratio worm gearbox. Such a test is very useful to compare finite element torque analysis with real prototype measurements.

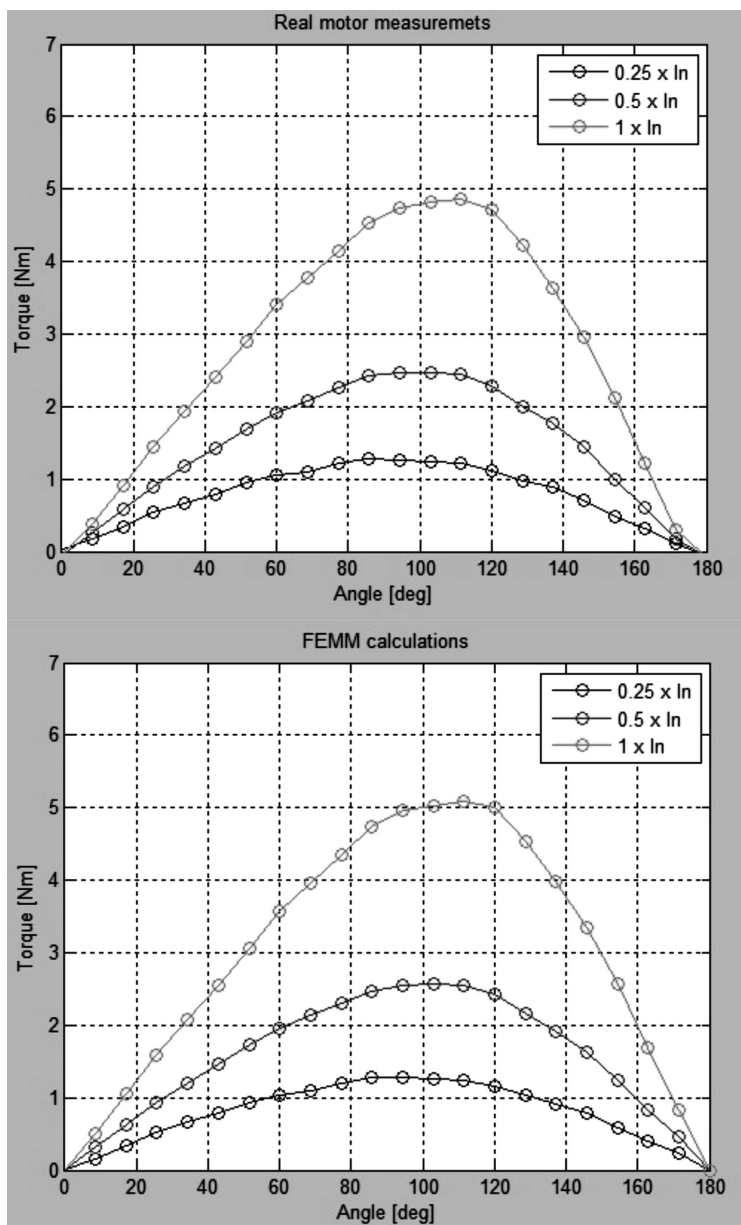

Fig. 6. Torque against angle, 10 poles (In, 0.5xIn, 0.25xIn)

It avoids some influences which are sometimes not predictable during normal test runs with a converter. In Tables 4 and 5, the efficiencies for different load points of both motors are shown. As can be seen, the main assumption relating to efficiency was fulfilled for two machines. A level of 90% is reached for the rated power at the rated speed. At the end of this paragraph, in Table 3, mechanical parameters of each construction are shown.

In motors with concentrated windings, the problem of vibrations and noise can be significant. Magnetic pull due to the relatively thin stator's jock is able to bend the housing and the stator. In the construction with 4 poles and 24 slots, there are four periods of electromagnetic pull around the motor. But in the construction with 10 poles and 12 teeth, there are only two periods of electromagnetic pull around the motor. As long as the motor is optimized for high efficiency, the air gap must be thin. Due to the thin air gap, all mechanical stresses are not smoothed. So the problem of increased noise was seen during the first tests either with or without load. So the noise tests were carried out to measure and to compare the 10 pole motor to the 4 pole motor. It can be easily seen (Fig. 7) that the 10 pole motor is not a perfect construction. From the beginning it looked as if the main sources of the sound were bearing covers and the fan cover. Therefore, the special bearing covers were designed and tested. As can be seen, the improvement is significant at around 5 dB for load condition. In the near future, a second prototype will be finished. Stator will be segmented which will probably improve the damping factor of the mechanical vibrations. Additionally, winding's filling factor is higher for the segmented stator compared to one-piece construction.

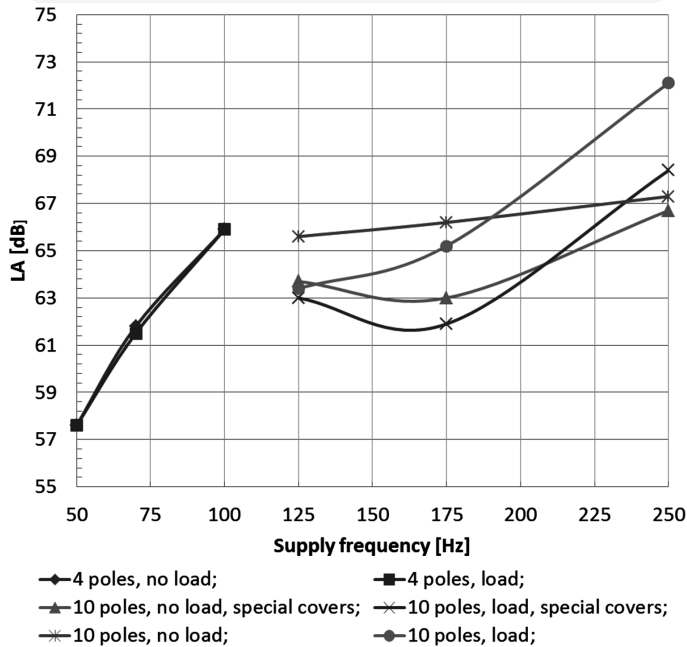

Fig. 7. Level of noise, 1 m distance. Speed range is 1500–3000 RPM for both motors

#### 4. Conclusion and comments

The conducted research shows that the finite element method could be the only one during the whole design process. One time written software is flexible. Could be useful for few types of topologies of the machine. Additionally, the accuracy is high enough to rely on software in



the case of electromagnetic torque, EMK, cogging torque. Iron and mechanical losses must be calculated in an analytical way. The electromagnetic model in this case will be a source of flux density in the steel. Of course, special parameters (factors) dependent on mechanical features like steel type, punching process, assembly process must be taken into account in the equations. Comparison shows that for PMSM rather fractional slots winding is more proper. The differences between these two motors in material usage are huge. By using concentrated winding, where losses in the end winding part are drastically decreased, current density in the wire could be fully exploited. This fact leads to length and weight reduction of the motor.

Table 3

#### Mechanical parameters of optimized constructions

Parameter	4 poles	10 poles
Stator outer diameter	120 mm	120 mm
Stator inner diameter	70 mm	68 mm
Air gap	0.5 mm	0.5 mm
Package length	60 mm	30 mm
End winding high	28 mm	9 mm
Active part length	116 mm	48 mm
Magnet thickness	2.5 mm	2.5 mm
Pole distortion	1.7 mm	0.8 mm
Stator's tooth wide	4.8 mm	10 mm
Stator's joke high	10 mm	7 mm
Slot entry gap	2.3 mm	2.8 mm
Pole space	0.075	0.068
Magnet amount	170g	106g
Magnet type	N38SH	N38SH
Steel amount	3.8 kg	1.6 kg
Steel type	M400-50A	M330-35A
Copper amount	1.4 kg	0.55 kg

Additionally, costs are reduced, which is an important consequence. Nowadays, winding technology is so advanced that the production process of such winding is easy and cheap both, in needle winding and in the separated tooth method.

Table 4

#### Efficiency measurements, 4 poles motor

Load	20%	40%	60%	80%	100%	120%	140%
Efficiency	85.5%	91.1%	91%	90.9%	90%	88.9%	87.8%

Efficiency measurements, 10 poles motor

Load	25%	50%	75%	100%	125%
Efficiency	88.1%	91.7%	91.7%	90.7%	89.2%

Motors with fractional slots winding provide a good opportunity for future downsizing of drives. This is a very important fact for customers and machine designers. Despite few important advantages, further research must be done in the mechanical area. Especially in the case of motors with power above 1–1.5 kW, a well-designed housing is required – otherwise, fractional slot construction can create high noise and vibrations.

### References

- [1] Salminen P., *Fractional slot permanent magnet synchronous motors for low speed applications*, Ph.D. thesis, Lappeenranta University of Technology, 2004.
- [2] Skaar S.E., Krovel O., Nilssen R., *Distribution, coil-span and winding factors for PM machines with concentrated windings*, Publications of NTNU, 2008.
- [3] Bianchi N., *Electrical machine analysis using finite elements*, CRC Press, 2005.
- [4] Reece A.B.J., Preston T.W., *Finite element method in electrical power engineering*, Oxford Science Publications, 2000.
- [5] Weizhong F., *Permanent Magnet Synchronous Machines with Fractional Slot and Concentrated Winding Configuration*, Ph.D. thesis, Cranfield University, 2011.
- [6] Salminen P., Libert F., *Torque ripple of permanent magnet machines with concentrated Winding*, ISEF, 2005.