

WOJCIECH CZUCHRA*, WOJCIECH MYSIŃSKI*, BARTOSZ WOSZCZYNA**

ELECTROMAGNETIC COMPATIBILITY OF SiC TECHNOLOGY POWER CONVERTER

KOMPATYBILNOŚĆ ELEKTROMAGNETYCZNA PRZEKSZTAŁNIKA ENERGOELEKTRONICZNEGO WYKONANEGO W TECHNOLOGII SiC

Abstract

Producers of power electronics components are currently introducing silicon carbide (SiC) to their products and MOSFET transistors made with this technology, working at a wide voltage and current range, are affordable. They are distinguished by high frequency of operation, reaching 100 kHz and low switching losses. Silicon carbide technology allows to build power converters, which are characterized by high efficiency, smaller dimensions, smaller passive components and higher thermal tolerance in comparison with traditional technology (Si). The aspect of the electromagnetic compatibility of SiC technology converter was analyzed in the article. Determined levels of interferences generated by the converter into the supply grid in the range of harmonics and inter-harmonics were presented. Measurement results of electromagnetic conducted disturbances were presented. Increased levels may make it difficult to fulfil standard requirements and may adversely affect the operation of devices connected to the same supply network. Additionally, conducted disturbance levels at converter output have also been analyzed, of which increase may lead to problems in providing the so-called inner compatibility of the tested circuit or may be a source of radiated electromagnetic emission. The results of tests and analysis, presented in the article, conducted for wide frequency range, allow to evaluate the silicon carbide (SiC) technology application for a converter in the EMC scope.

Keywords: power electronics, transistors SiC electromagnetic compatibility

Streszczenie

Producenci komponentów energoelektronicznych wprowadzają obecnie do swoich produktów węgiel krzemu (SiC) a tranzystory MOSFET wykonane w tej technologii, pracujące w szerokim zakresie napięciowym i prądowym są dostępne na rynku. Charakteryzują się one wysoką częstotliwością pracy sięgającą 100 kHz i niskimi stratami przełączania. Technologia węgla krzemu umożliwia budowę przekształtników energoelektronicznych, które charakteryzują się w porównaniu z tradycyjną technologią (Si), wysoką sprawnością, mniejszymi gabarytami, mniejszymi elementami pasywnymi oraz większą tolerancją termiczną. W artykule przeanalizowano aspekt kompatybilności elektromagnetycznej przekształtnika wykonanego w technologii SiC. Zaprezentowano wyznaczone poziomy zakłóceń generowanych przez przekształtnik do sieci zasilającej w zakresie harmonicznych i interharmonicznych. Przedstawiono wyniki zaburzeń elektromagnetycznych przewodzonych generowanych do sieci zasilającej, których zwiększone poziomy mogą utrudniać spełnienie przez przekształtnik odpowiednich wymogów normatywnych oraz mogą wpływać niekorzystnie na pracę urządzeń przyłączonych do tej samej sieci zasilającej. Dodatkowo przeanalizowano poziomy zaburzeń elektromagnetycznych przewodzonych również na wyjściu układu przekształtnikowego, których zwiększone poziomy mogą doprowadzić do problemów w zapewnieniu tzw. kompatybilności wewnętrznej badanego układu lub być źródłem emisji elektromagnetycznej promieniowanej. Przedstawione w artykule wyniki badań i analiz przeprowadzone w szerokim paśmie częstotliwości umożliwiając ocenę zastosowania technologii węgla krzemu (SiC) w układzie przekształtnika w zakresie EMC.

Słowa kluczowe: energoelektronika, tranzystory SiC, kompatybilność elektromagnetyczna

* Ph.D. Eng. Wojciech Czuchra, M.Sc. Eng. Bartosz Woszczyzna, Department of Traction and Traffic Control, Faculty of Electrical and Computer Engineering, Cracow University of Technology.

** Ph.D. Eng. Wojciech Mysiński, Institute of Electrical Engineering and Computer Science, Faculty of Electrical and Computer Engineering, Cracow University of Technology.

1. Introduction

The electromagnetic compatibility of converter drive systems includes the system's emissivity and immunity issues. In the scope of the system's emission, among others, harmonics in the frequency range below 9 kHz and conducted electromagnetic disturbances for a bandwidth from 150 kHz to 30 MHz are considered [1, 2].

Harmonics content in voltage and current signal is an important issue related to the energy quality. There are many calculative analytical methods of harmonics content, determining distorted signals. Those methods are also indicated in appropriate standard documents. Those calculations are conducted with a view to energy quality and in view of safety, e.g. influence of harmonics in the supply current of traction vehicles on railway traffic control circuits [3].

Harmonics, as sinusoidal signals of frequency equal to whole times of signal's basic frequency, may be evaluated individually by the relative value of the signal amplitude related to the signal value of the basic component or altogether by total harmonics distortion factor [1]. Spectrum components, of which frequency is non-whole times of signal's basic frequency, are called inter-harmonics. They can appear as discrete frequencies or as a broadband spectrum and they are generated as a result of signal amplitudes' or phase angles' alteration or switching semiconductor elements in static converters unsynchronized with the supply network frequency.

High operating frequency together with high signal steepness at output of converters made with silicon carbide technology may be associated with the increase of electromagnetic disturbance levels generated by the system [4]. The generated disturbances, depending on the system's parameters and switching method, and resulting from energy conversion, occur technically in the whole considered frequency bandwidth. High switching frequency of power electronics components leads to a shift of those disturbances into the conducted disturbances bandwidth (from 9 kHz (150 kHz) to 30 MHz), which may also require a reduction of the conducted disturbances emission or even a reduction of the radiated disturbances with filtering methods [5]. The conducted research of the EMC phenomenon in SiC converter drives, both individual and comparative with Si technology systems, are the subject of many scientific articles, which indicates a topicality of that matter [6, 7]. Propositions of new methods and means of limiting problems related to EMC are also a subject of considerations [8, 9].

2. Tested system and research methodology

The converter system with a voltage-source pulse width modulation (PWM) inverter built on the basis of silicon carbide technology components (SiC-MOSFET, SCT2160KEC, Rohm) was constructed in order to conduct laboratory tests in the scope of electromagnetic compatibility. The constructed converter unit, working as a drive for an asynchronous squirrel-cage motor (SZJe 340), was tested in the scope of electromagnetic compatibility. During the tests, the system was operating at identical supply, load and switching conditions, without the use of filtering devices. The measurement of frequency characteristics was

conducted according to the basic requirements of standard PN-EN 61800-3 [1]. Current probe HAMEG HZ56 was used as a current transducer and A/C transducer Dewetron 43 was used as a recording device for harmonics and inter-harmonics measurements. Spectrum analyzer Rohde&Schwarz FSL3, voltage probe SCHWARZBECK MESS – ELEKTRONIK TK9420 and current probe TESEQ CSP 9160A were used for carrying out measurements of conducted electromagnetic disturbances. The measured characteristics were determined with a peak detector. A simplified measurement setup of the converter drive is shown in Fig. 1., and a view of the measurement stand is shown in Fig. 2. Additionally, a measurement of magnetic induction was conducted with magnetic field measuring coil EMCO 7604 and with spectrum analyzer Rohde&Schwarz FSL3.

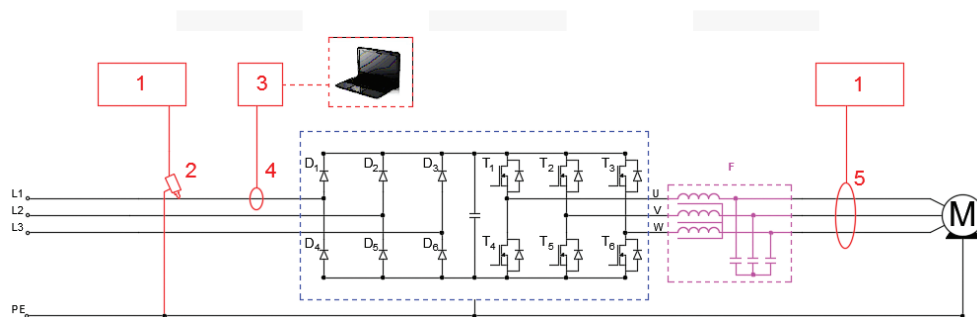

Fig. 1. A simplified measurement setup of converter drive, 1 – spectrum analyzer, 2 – voltage probe, 3 – A/C transducer, 4 – current probe HZ56, 5 – current probe CSP9160A, F – sinusoidal filter

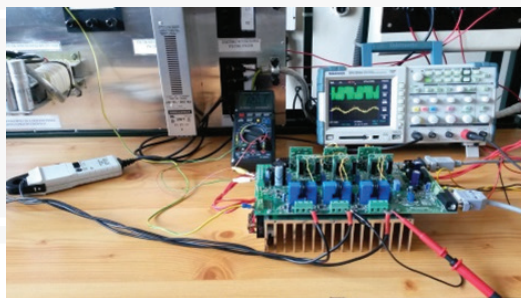

Fig. 2. A view of the measurement stand for tested converter drive system

3. Harmonics and inter-harmonics tests

In the case of electrical drive systems with varying speed, the requirements concerning harmonics' emission are included in standard PN-EN 61800-3. According to the standard, harmonics should be determined at nominal load as the percentile content related to the basic component of current, up to at least order 25. THD current factor (up to order 40) and high-frequency component PHD should be determined.

Considering a device supplied from public low voltage network, the above standard refers to the limit values included in standard PN-EN 61000-3-2 [10], which lists four device classes – A, B, C and D. The considered converter drive system, due to the 3-phase power supply, is assigned to class A.

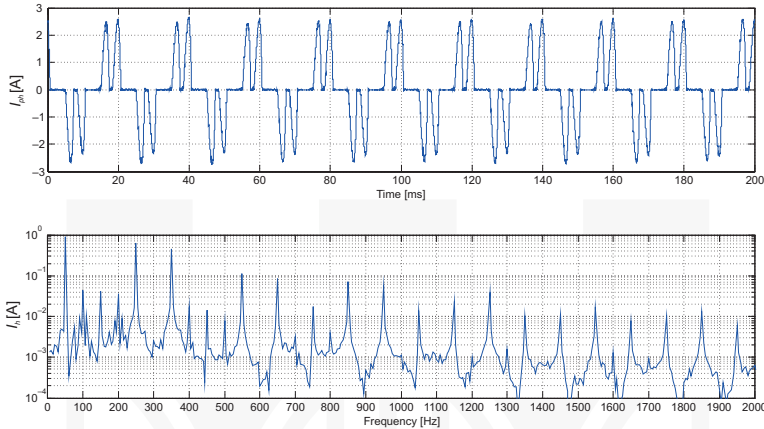

Fig. 3. Varying component of input phase current (I_{ph}) and current harmonics spectrum (I_h) for $f = 6.5$ kHz

Harmonics content and time waveform of the input phase current of the tested system is shown in Fig. 3 (carrier frequency $f = 6.5$ kHz) and Fig. 4 (carrier frequency $f = 82$ kHz). A results summary, concerning odd harmonics, with permissible values according to standard [10], is shown in Table 1 and Fig. 5. The comparison is shown with limit to order 19, due to very low values of higher orders harmonics (below 10 mA) and accuracy of measuring equipment. Because of the very low content of even harmonics in the considered signal (about 10 mA and less), the comparison of results with permissible values is not presented.

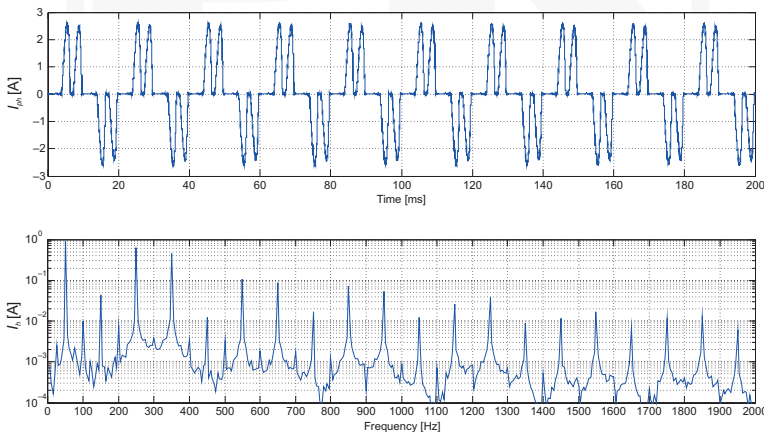

Fig. 4. Varying component of input phase current (I_{ph}) and current harmonics spectrum (I_h) for $f = 82$ kHz

Table 1

Harmonics content in supply current of tested system

Harmonics order	f_h [Hz]	Ihperm [A]	I_h [A]	I_h [%]	I_h [A]	I_h [%]
			for $f=6.5$ kHz	for $f=6.5$ kHz	for $f=82$ kHz	for $f=82$ kHz
3	150	2.300	0.041	4.6	0.044	4.8
5	250	1.140	0.636	70.6	0.640	69.9
7	350	0.770	0.455	50.5	0.451	49.3
9	450	0.400	0.015	1.7	0.012	1.3
11	550	0.330	0.111	12.3	0.106	11.6
13	650	0.210	0.085	9.4	0.088	9.6
15	750	0.150	0.018	2.0	0.017	1.9
17	850	0.132	0.071	7.9	0.073	8.0
19	950	0.118	0.057	6.3	0.055	6.0

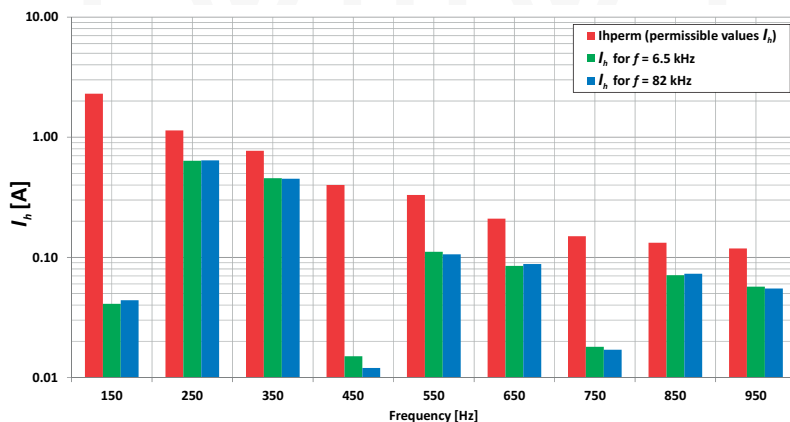

Fig. 5. Comparison harmonics content in supply current with permissible values according to standard PN-EN 61000-3-2 for $f=6.5$ kHz and $f=82$ kHz

Factors describing the total harmonics content in the converter's supply current were calculated based on determined levels of individual harmonics. They are presented in Table 2. Total Distortion Ratio (TDR), Total Distortion Factor (TDF), Total Harmonic Distortion (THD), Total Harmonic Factor (THF) and Partitive Harmonic Distortion (PHD) factors were determined. The above factors are defined as:

- Total Distortion Ratio TDR taking inter-harmonics into account:

$$\text{TDR} = \frac{\sqrt{I^2 - I_1^2}}{I_{1N}} \quad (1)$$

where:

- I – total root mean square,
- I_1 – root mean square of basic component,
- I_{1N} – nominal root mean square of basic component,

- Total Distortion Factor TDF taking inter-harmonics into account:

$$\text{TDF} = \frac{\sqrt{I^2 - I_1^2}}{I_N} \tag{2}$$

where:

- I – total root mean square,
- I_1 – root mean square of basic component,
- I_N – nominal total root mean square,

- Total Harmonic Distortion THD omitting inter-harmonics:

$$\text{THD} = \frac{\sqrt{\sum_{h=2}^{h=40} I_h^2}}{I_{1N}} \tag{3}$$

where:

- I_h – root mean square of h-order harmonic,
- I_{1N} – nominal root mean square of basic component,

- Total Harmonic Factor THF omitting inter-harmonics:

$$\text{THF} = \frac{\sqrt{\sum_{h=2}^{h=40} I_h^2}}{I_N} \tag{4}$$

where:

- I_h – root mean square of h-order harmonic,
- I_N – nominal total root mean square,

- Partitive Harmonic Distortion PHD omitting inter-harmonics:

$$\text{PHD} = \frac{\sqrt{\sum_{h=14}^{h=40} I_h^2}}{I_{1N}} \tag{5}$$

where:

- I_h – root mean square of h-order harmonic,
- I_{1N} – nominal root mean square of basic component.

Table 2

Factors describing the harmonics content in the tested system

	$f= 6.5$ kHz	$f= 82$ kHz	Notes:
TDR [%]	90	88	with inter-harmonics
TDF [%]	67	66	with inter-harmonics
THD [%]	89	88	without inter-harmonics
THF [%]	67	66	without inter-harmonics
PHD [%]	12	12	without inter-harmonics

The determined distortion factors of tested converter drive's supply current show a significant influence of higher harmonics on current waveform. The presented comparisons show no influence of current inter-harmonics on factors describing the total harmonics content. Primarily higher harmonics influence the converter's supply current distortion. Calculations also confirmed that there is a difference between THD and THF factors in current analysis, which is not so evident in voltage analysis. The obtained results for the PHD factor, which shows influence of higher order harmonics (14–40), confirmed their small contribution to supply current distortion. A comparison of all factors determined for two carrier frequencies of inverter ($f=5.6$ kHz and $f=82$ kHz) allows us to deduce that there is no significant influence (difference of 1%) of this parameter on current distortion in the considered frequency range.

4. Conducted electromagnetic disturbances and magnetic fields research

As a result of the carried out laboratory tests for the conducted disturbances in the frequency range from 150 kHz to 30 MHz, a number of findings were obtained. Based on them, it was noticed that there are possible issues of electromagnetic compatibility scope with SiC inverters.

Measurements of frequency characteristics were conducted for the converter system. Signals at input (from supply side) and output (from motor side) of the inverter were chosen. The inverter was operating at identical supply and load condition, carrier frequency 6.5 kHz and 82 kHz and 50 Hz output frequency. The first comparisons shown in Fig. 6 and 7 concern the influence of SiC inverter's carrier frequency on the conducted disturbance level. Voltages and currents of the conducted disturbances at $f=6.5$ kHz are shown in blue, while at $f=82$ kHz are shown in green. Additionally, limit values (Limit 1 – category C1 and Limit 2 – category C2) for the conducted disturbances, according to standard PN-EN 61800-3 for quasi-peak value, are marked in Fig. 6. Despite presenting the results for the peak value of disturbances, it can be assumed, with high probability, that the limit levels of input non-symmetrical disturbance voltage would also be exceeded for the quasi-peak detector.

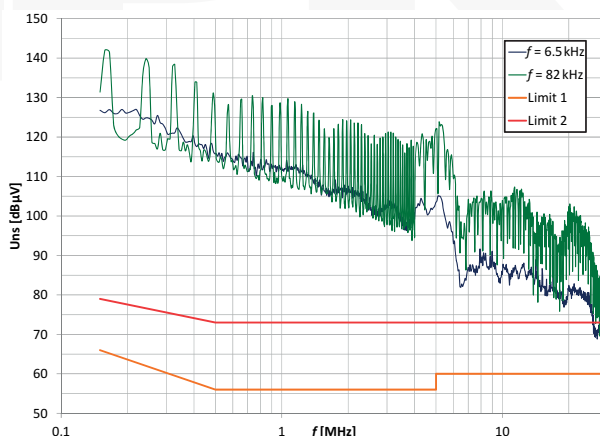

Fig. 6. Comparison of non-symmetrical voltages of conducted disturbances for different carrier frequencies

The obtained measurement results of spectrums clearly show that an inverter working with carrier frequency increased to 82 kHz generates higher levels of conducted disturbances in the whole frequency bandwidth at the supply side as well as from the load side. Level increment of both input and output disturbance voltage and current reaches a maximum of about 20 dB. Using the possibility of SiC semiconductors working with significantly higher carrier frequencies may cause difficulties with providing the electromagnetic compatibility.

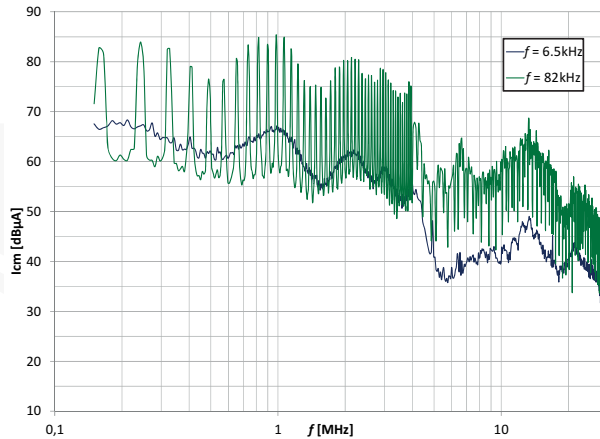

Fig. 7. Comparison of output asymmetrical currents of conducted disturbances for different carrier frequencies

A increased level of electromagnetic conducted disturbances may result in increased levels of electromagnetic fields in the converter system's surroundings. Measurements of magnetic induction at 30 cm from the tested system were carried out in order to investigate fields emission. Measurements were carried out for frequency the bandwidth from 150 kHz to 1 MHz. Results' comparison for carrier frequencies 6.5 kHz and 82 kHz is presented in Fig. 8.

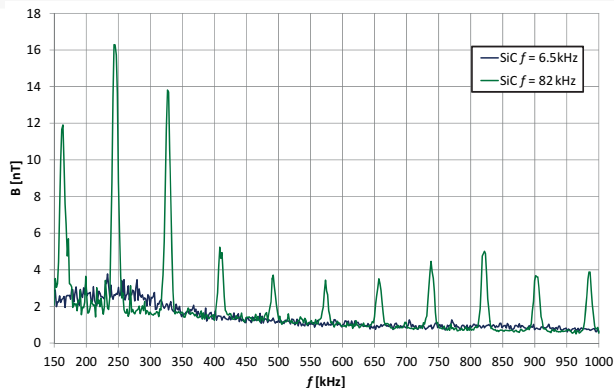

Fig. 8. Comparison on magnetic induction in converter's surroundings for different carrier frequency

The presented comparison confirms that increased levels of conducted disturbances of SiC converter operating at higher carrier frequencies result in higher levels of outer electromagnetic fields. That issue should be also considered when designing converter systems using semiconductors made with the silicon carbide technology.

5. Limiting the EMC problems

Manufacturers of converter drive systems often resign of additional inductive elements or complete input filters, which may easily improve the EMC situation of the system. Those components reduce the harmonics emission into the supplying grid, reduce the emission in the scope of electromagnetic conducted and radiated disturbances, but also protect the system from a number of phenomena, which may damage the system's elements.

Paying attention especially to EMC problems, the converter system output results from the possibility of additional costs caused by e.g. damage of motor cable or motor alone. Control measurements and potential use of means improving converter drive's reliability, such as: dv/dt chokes and filters, filters, motor chokes or sinusoidal output filters, are often required. The task of a typical sinusoidal filter working as a low-pass filter is to convert the inverter's (PWM) output signal to a smoothed sinusoidal signal. Fragmentary pulsations may be adjusted by the choice of LC elements. Additional tests were conducted in the article using the FN5010 sinusoidal filter, of which parameters are: nominal operating voltage: 3 x 400 Vac, motor frequency 0 to 70 Hz, switching frequency 4 to 16 kHz, rated currents 13A and $L = 4.2$ mH, $C = 1.5$ μ F.

The waveform of phase-to-phase voltage and phase current before sinusoidal filter are shown on Fig. 9. The presented results were obtained for a converter drive system working with a fundamental frequency of 50 Hz. The shape of output voltage corresponds to typical PWM inverter's output voltage waveform, with high voltage steepness and a big contribution of pulsations being noticeable in current waveform.



Fig. 9. Phase-to-phase voltage (CH4) and phase current (CH1) waveform before sinusoidal filter from inverter side

The waveform of phase-to-phase voltage and phase current after sinusoidal filter from motor side are shown on Fig. 10.

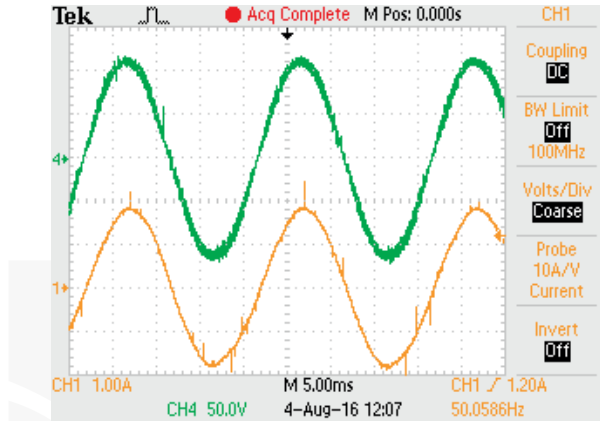

Fig. 10. Phase-to-phase voltage (CH4) and phase current (CH1) waveform after sinusoidal filter from motor side

The used filter formed the phase-to-phase voltage into sinusoidal wave, reduced the steepness of voltage pulses and minimized the pulsation of phase current.

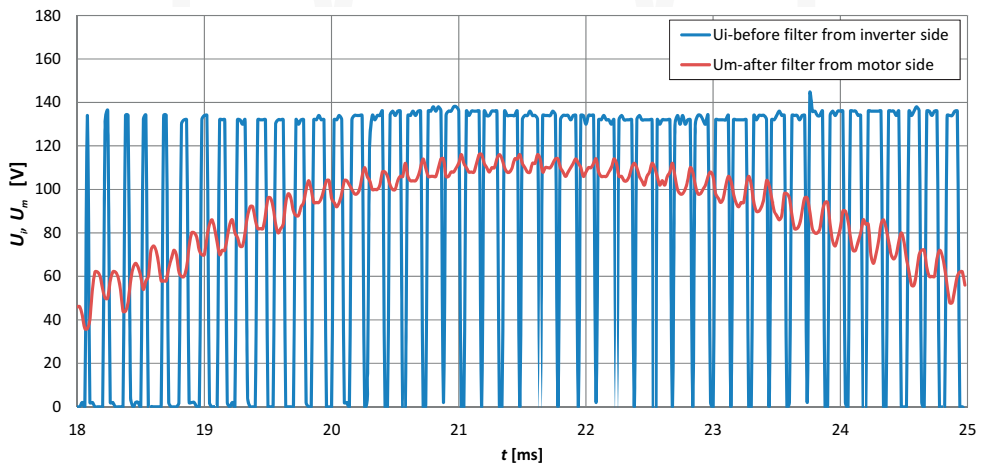

Fig. 11. Phase-to-phase voltage waveform (U_i) before filter from inverter side and (U_m) after sinusoidal filter from motor side (zoom)

A deep analysis of results showed that the sinusoidal input filter used in the tested system has also reduced the motor's phase current pulsations thrice from $p(I_i) = 15\%$ to $p(I_m) = 5\%$ (Fig. 12). Higher harmonics in the motor's phase current related to inverter's switching frequency have also been reduced. The reduction of harmonics levels is about 10 times.

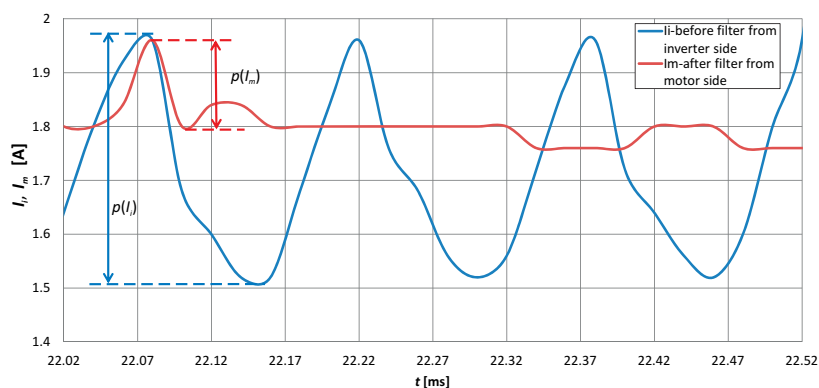

Fig. 12. Phase current waveform (I_i) before filter from inverter side and (I_m) after sinusoidal filter from motor side (zoom)

As shown by test conducted in time domain, the used sinusoidal filter formed a motor's supply voltage waveform with limited pulsations and reduced voltage steepness (Fig. 10, Fig. 11). It will provide the motor and the cable protection from high dv/dt and overvoltage, magnetic losses reduction, acoustic interferences reduction and increase of the whole system's reliability. The modified sinusoidal filter may be required to solve the remaining problems like high frequency line-to-ground current, bearing currents or the possibility of using very long non-screened cables. It comprises a connection of typical symmetrical sinusoidal filter and an asymmetrical filter with additional connection with intermediate DC circuit.

6. Summary

The conducted investigation of laboratory converter drive constructed with transistors made with SiC technology may be a base to a preliminary evaluation of the silicon carbide (SiC) technology application in the aspect of electromagnetic compatibility. The conducted tests in the frequency range below 9 kHz, including the bandwidth of harmonics and inter-harmonics emission, did not show increased emission levels. The results of individual analysis and group evaluation factor showed that signals dominating in that range include a group of odd harmonics, and the contribution of inter-harmonics and higher order harmonics is relatively low. Based on the obtained results, the possible side effects of the application of the SiC technology in converter drive systems was indicated. It may cause difficulties with providing system's electromagnetic compatibility. During analysis of electromagnetic disturbance levels in the bandwidth from 150 kHz to 30 MHz, it has been established that, for a SiC converter system, the carrier frequency increase from 6.5 kHz to 82 kHz brought significant an increase of the conducted disturbance levels. In further consequence, it results in, what was proved, that inverter with SiC transistors working with higher carrier frequencies is a source of an increased level of outer magnetic fields. The silicon carbide technology allows to build power converters, which are characterized by high efficiency (low losses in transistors), smaller dimensions, smaller passive components

and higher thermal tolerance in comparison with traditional technology (Si). However, those elements are a bigger threat for the electromagnetic environment in respect of electromagnetic compatibility, which was confirmed by the conducted research. Increased levels of conducted disturbances at inverter's supply side may make it difficult to fulfil appropriate standard requirements and may be harmful for devices connected to the same supply network. On the other hand, increased disturbance level at system's output may result in troubles with providing the so-called inner compatibility. Then, a requirement of using output components appears, e.g. sinusoidal filter, which was a subject of research. Test results showed that it will be necessary to use many methods of electromagnetic disturbances reduction in order to make the tested converter drive fulfil the standard requirements in the EMC scope and in order to increase system reliability. Research results showed that there will be a necessity of using systems lowering electromagnetic disturbance levels in order to fulfil standard requirements in the EMC scope by a converter drive.

References

- [1] Standard PN-EN 61800-3:2008 – Adjustable speed electrical power drive systems – Part 3: EMC requirements and specific test.
- [2] Czuchra W., Zajac W., *Electromagnetic Conducted Interferences in Laboratory Converter Drive*, Technical Transactions, vol. 1-E/2007, 23–30.
- [3] Skarpetowski G., Zajac W., Czuchra W., *Analytical Calculation of Supply Current Harmonics Generated by Train Unit*, 12th International Power Electronics and Motion Control Conference EPE-PEMC 2006, Portoroz 2006.
- [4] Czuchra W., Zajac W., *Investigation of Electromagnetic Interference Generated by a Tram and a Trolley-bus with Inverter Drives*, International Conference on ship propulsion and railway traction systems, Bologna, Italy, 4.5.6 October 2005.
- [5] Czuchra W., Mysiński W., Zajac W., *Modelling and Testing of RFI Filter for a Trolleybus Transistor Inverter*, EPE 2009 13th European Conference on Power Electronics and Applications, 8–10 September. Barcelona, Spain.
- [6] Gong X., Ferreira J.A., *Comparison and Reduction of Conducted EMI in SiC JFET and Si IGBT-Based Motor Drives*, IEEE Transactions on Power Electronics, vol. 29, no. 4, April 2014, 1757–1766.
- [7] Czuchra W., Mysiński W., Woszczyzna B., *Analysis of the use Transistors Based on SiC Technology in Inverters in the context of Electromagnetic Compatibility*, Technical Transactions, 1-E/2016, 2016, 33–43.
- [8] Gong X., Josifovic I., Ferreira J. A., *Comprehensive CM Filter Design to Suppress Conducted EMI for SiC-JFET Motor Drives*, Proc. IEEE 8th International Conference on Power Electronics, ECCE Asia, 2011, 720–727.
- [9] Akagi H., Shimizu T., *Attenuation of Conducted EMI Emissions From an Inverter-Driven Motor*. IEEE Transactions on Power Electronics, vol. 23, no. 1, January 2008, 282–290.
- [10] Standard PN-EN 61000-3-2: Electromagnetic compatibility (EMC)-Part 3-2-Limits. Limits for harmonic current emissions (equipment input current ≤ 16 A per phase).