

Łukasz Flaga  orcid.org/0000-0001-9650-4913

lukasz.flaga@interia.pl

Aleksander Pistol  orcid.org/0000-0002-6282-4596

aleksander.pistol@gmail.com

Piotr Krajewski  orcid.org/0000-0002-2635-7273

piotrekrajewski@gmail.com

Andrzej Flaga  orcid.org/0000-0003-1759-4872

liwpk@windlab.pl

Institute of Structural Mechanics, Cracow University of Technology

MODEL TESTS OF DYNAMIC ACTION ON THE ATMOSPHERIC BOUNDARY  
LAYER – LINEAR CONFIGURATION OF VENTILATION TOWERS  
ON A ROUGH TERRAIN

BADANIA MODELOWE DYNAMICZNEGO ODDZIAŁYWANIA  
NA WARSTWĘ PRZYZIEMNĄ ATMOSFERY – KONFIGURACJA LINIOWA  
WIEŻ WENTYLACYJNYCH NA CHROPOWATYM TERENIE

**Abstract**

This paper describes model tests conducted at the Wind Engineering Laboratory of Cracow University of Technology as the first stage of studies on dynamic action on the atmospheric boundary layer in order to reduce the effects of air pollution and smog. It focuses on the cooperation between a series of ventilation towers placed one by one (or row by row) in order to generate a continuous airstream with sufficient velocity to aid the natural ventilation of urban areas. The tests were conducted for three different terrain categories with varying roughness. Also tested were different wind speeds, different spacing between the towers and different configurations of the towers in each row. As a preliminary set of tests, this enabled verification of the feasibility of the solution and its effectiveness on a rough terrain that simulates urban areas.

**Keywords:** wind engineering, smog reduction, environmental engineering, urban ventilation, terrain roughness

**Streszczenie**

Niniejszy artykuł opisuje badania modelowe przeprowadzone w Laboratorium Inżynierii Wiatrowej Politechniki Krakowskiej w ramach pierwszego etapu studium dynamicznego oddziaływania na warstwę przyziemną atmosfery w celu redukcji zanieczyszczenia powietrza i smogu. Praca skupia się na współpracy kilku wież wentylacyjnych ustawionych jedna za drugą (lub rząd za rządem) w celu utworzenia ciągłej strugi powietrza o dostatecznej prędkości, by wspomóc naturalną wentylację obszarów zurbanizowanych. Badania przeprowadzono dla trzech różnych kategorii chropowatości terenu. Ponadto sprawdzono wpływ różnych prędkości strugi, różnych odległości pomiędzy wieżami i różnych wzajemnych konfiguracji wież w każdym rzędzie. Przeprowadzone badania wstępne pozwoliły na weryfikację wykonalności tego rozwiązania oraz jego wydajności na chropowatym terenie odpowiadającym obszarom zurbanizowanym.

**Słowa kluczowe:** inżynieria wiatrowa, redukcja smogu, inżynieria środowiska, przewietrzanie miast, chropowatość terenu

## 1. Introduction

The problem of smog and excessive air pollution is faced by many modern cities. Thus far, the countermeasures for this problem have been limited to restrictions of car traffic, the modernisation of coal-fuelled heating systems and active air purifiers, which have a very localised impact range. The idea of these studies is to apply large ventilation towers (shown in Fig. 1) for creating artificial airstreams within cities. Groups of such devices would form part of a large-scale ventilation system. Its objective would be to ensure the uninterrupted operation of natural ventilation arteries of the cities, even during windless weather (see Fig. 2). This should effectively improve the urban air quality by supporting the natural system of air exchange and regeneration. In order to obtain maximum efficiency of the system, some investigations and tests need to be performed to define both the most vital points of the urban layout requiring support by such system and the range of the most economic configuration of the system elements.

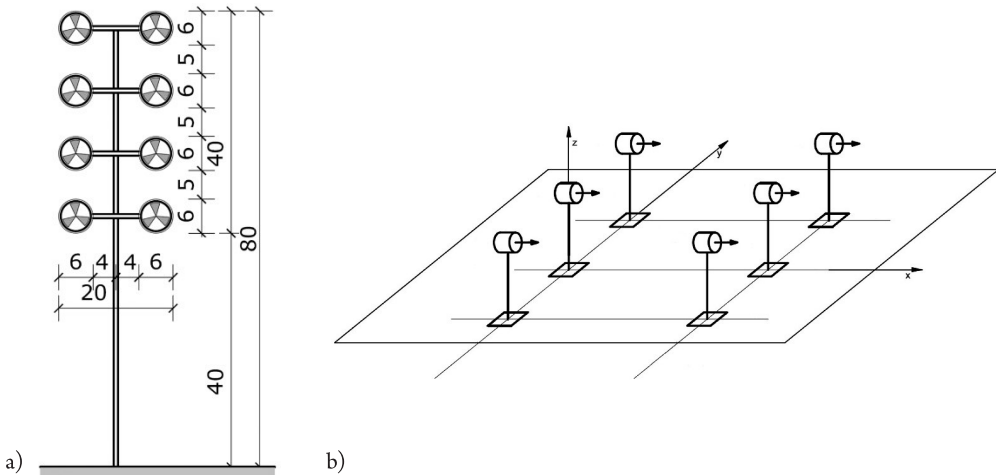

Fig. 1. Scheme of the proposed ventilation tower (a) with 10 large fans (all dimensions in [m]) and configuration of system elements for creating artificial airstreams (b)

This large-scale ventilation system would be put to use during windless periods when pollution is accumulated in the air. If proven to work (i.e. proven to create a continuous airstream of desirable wind speed) at the scale of the model and on rough terrain, the solution should be tested at a larger scale before implementation in real life. Furthermore, subsequent stages of preliminary tests will focus on the manner of expelling the polluted air from the atmospheric boundary layer and the cooperation between the ventilation towers and the exhaust system.

The literature review will cover the study of dynamic action on the atmospheric boundary layer. The authors aim to investigate whether it is possible to force the movement of air mass on such a large scale. The study will also include an analysis of the effectiveness of dynamic action on the atmospheric boundary layer. To emphasise the pioneering nature of this type of research, it is worthwhile to analyse the current state of knowledge in the field of urban

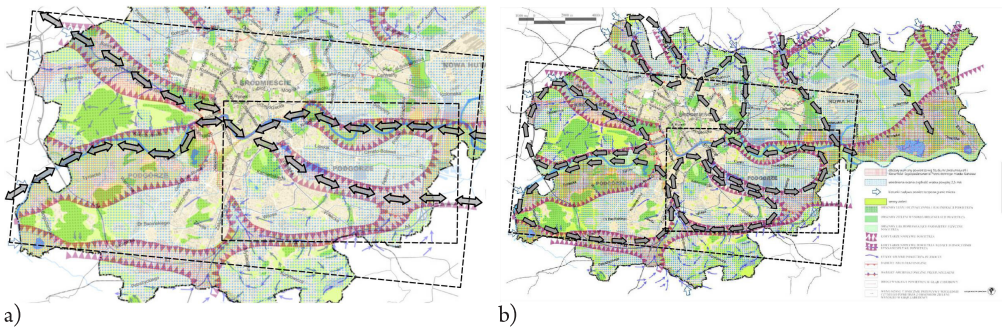

Fig. 2. Concept sketch of additional air streams mechanically generated on the example of an air exchange and regeneration system for Cracow [1]: a) horizontal air streams in parallel configuration of stream generation points; b) horizontal vortex air streams in circulating configurations of stream generation points

ventilation as well as the forced movement of air masses. Thus, the following are some of the relevant studies that have been conducted and described so far:

- ▶ **studies of natural ventilation channels in urban areas:** CFD simulations of air pollution dispersion in urban areas [2, 3], wind tunnel tests of wind conditions in urban areas [4], comparisons of CFD results with wind tunnel measurements [3], influence of the terrain (buildings, roughness, etc.) on natural ventilation channels [5–8];
- ▶ **influence of wind conditions** on the transport of air pollution outside urban areas as well as on the change of urban microclimatic conditions [9];
- ▶ **study on the phenomenon of forced air movement on a small scale** (home ventilation) [10, 11];
- ▶ **study of natural vertical air movement:** the impact of cities' thermal conditions on their ventilation [12–14];
- ▶ **study of forced vertical air movement:** increasing the efficiency of small-scale ventilation by creating a tornado-like artificial vortex [15]; patent for a cooling tower with forced ventilation and natural draft [16] or cooling tower discharging of polluted air after breaking through the inversion layer [17, 18]; study of the process for reducing smog by the chimney inversion/injector effect – sucking warmer and cleaner air from the higher layers towards the ground via pipelines [19];
- ▶ **aerodynamic interference test:** mainly aerodynamic interference study of buildings [20]; investigation of generated air-stream interference in only the vertical direction and on a small scale [21];
- ▶ **similarity criteria for the phenomenon of dynamic action on the atmospheric boundary layer:** only own works discussed in the pre-test section.

Summing up the above literature review, it is evident that there are many gaps in the state of knowledge concerning the phenomenon of dynamic action on atmospheric boundary layer. However, paper [22] suggests using an air-exchange and regeneration system as a global active measure against bad aero-sanitary conditions in urban areas. Thus far, such a system has

been neither created nor applied. What is more, it has not been investigated whether it would be physically possible to create such a system or whether it be economically justified.

No one has ever thoroughly investigated the mechanical movements of air masses on such a large scale. Moreover, the effectiveness of such a dynamic action is not known. Additionally, there has so far been little information about the aerodynamic interference of the generated air streams. This phenomenon is particularly important since, as a result of air-stream interference, the efficiency of the system may be dramatically improved or hampered. Therefore, the objectives of the study were: the development of a practical model of air flow in urban areas along with elaborating basic similarity criteria for the analysed issue; the preparation of a work station for the measurement of an air-flow velocity field generated by ventilation towers in chosen variants of parallel configuration; the conducting of model tests to measure the air-flow velocity field in the proximity of ventilation towers in parallel configuration with different fan-rotation speeds, the number and location of the fans; smoke visualisation of the phenomena.

## 2. Testing methods

### 2.1. Similarity criteria

The first stage of tests concerned the dimension analysis required for this research. It was decided that most of the tests would be conducted on scale models. Model tests reflect reality with a satisfactory level of accuracy if the basic relations in the analysed phenomenon are preserved. Thus, the first key step in the initial test was to define these relations (i.e. similarity criteria) which must be fulfilled during the investigations. The following elements of the system were analysed, from the most basic to the most complex sets:

#### 2.1.1. Single ventilation tower with similar multiple parallel fans

As first, a ventilation tower equipped with similar multiple parallel fans was studied [23]. Its concept scheme showing the relevant parameters is shown in Fig. 3.

The x-component of the mean air-stream velocity at point P ( $x_p, y_p, z_p$ ) marked as  $V_{xp}$  is a function dependent on the following factors: geometric parameters of a ventilation tower ( $h_B, d, h, h_D, c, b$ ); geometric parameters of a single fan ( $d_w, l_w, \dots$ ) = ( $g_w$ ); mean outlet air velocity ( $v_w$ ); coordinates of point P: ( $x_p, y_p, z_p$ ); physical characteristics of air ( $\rho$  - mass density,  $\mu$  - dynamic viscosity,  $\nu = \frac{\mu}{\rho}$  - kinematic viscosity); terrain roughness parameters ( $k_{rt}$  - mean height of the surface irregularity – assuming quite uniformly rough terrain).

Based on all the above parameters, the undermentioned functional relationship can be stated:

$$V_{xp} = F \left[ h_B, d, h, h_D, c, b; (g_w); (x_p, y_p, z_p); v_w, \rho, \mu; k_{rt} \right]. \quad (1)$$

Assuming the dimensional base of the problem as ( $\rho, v_w, h$ ) and using the  $\Pi$  (Buckingham) theorem that concerns the dimensional analysis, the following dimensionless function is defined:

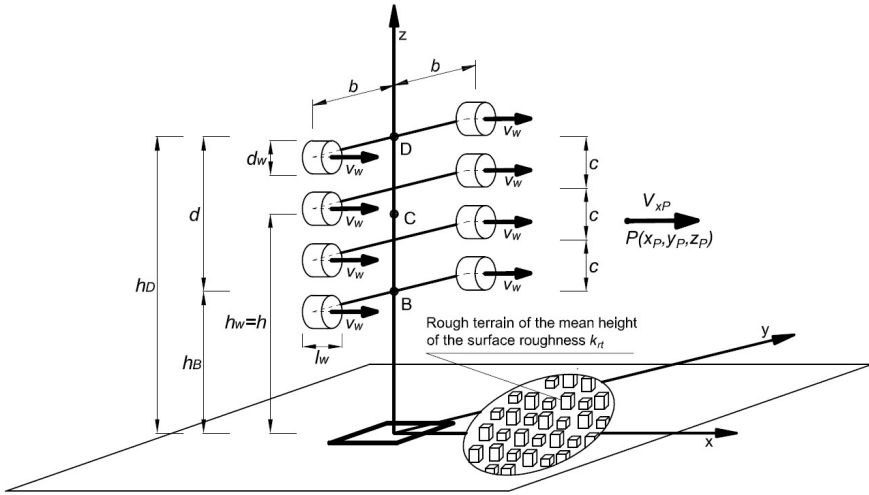

Fig. 3. Sketch of ventilation tower equipped with eight fans; each fan generates an air stream of mean outlet velocity  $v_w$

$$\check{V} = \frac{V_{xP}}{v_w} = \check{F} \left[ \frac{h_B}{h}, \frac{d}{h}, \frac{h}{h}, \frac{h_D}{h}, \frac{c}{h}, \frac{b}{h}; (\check{g}_w); \left( \frac{x_P}{h}, \frac{y_P}{h}, \frac{z_P}{h} \right); Re^*; \check{k}_{rt} \right] \quad (2)$$

where  $Re^* = \frac{v_w h_D}{\mu} = \frac{v_w h}{\nu}$  is a Reynolds number,  $\check{k}_{rt} = \frac{k_{rt}}{h}$  is the dimensionless roughness of the surface.

From the above relations, it follows that at given dimensionless geometric parameters of the ventilation tower and fans, the dimensionless velocity  $\check{V}$  depends on: dimensionless coordinates of point  $P \left( \frac{x_P}{h}, \frac{y_P}{h}, \frac{z_P}{h} \right)$ , Reynolds number  $Re$  and dimensionless roughness of the surface  $\check{k}_{rt}$ . The easiest method of achieving the individual values of the function  $\check{F}$  is by conducting a series of model tests.

### 2.1.2. Single ventilation tower with one substitutive fan

The stream generation point can be modelled in a simpler way than a single ventilation tower with one substitutive fan (Fig. 4) generating an air stream of with mass flow rate  $Q_w$  equal to the sum of mass flow rates  $\Sigma q_w$  of eight (or, in the general,  $n_w$ ) fans mounted on the ventilation tower presented in Fig. 3.

In this case:

$$Q_w = \rho A_w V_w = \rho \frac{\pi D_w^2}{4} V_w, q_w = \rho a_w v_w = \rho \frac{\pi d_w^2}{4} v_w, Q_w = n_w q_w = 8 q_w \quad (3-5)$$

where  $A_w$  is the area of the substitutive fan,  $a_w$  is the area of each single fan and  $V_w$  is the mean outlet velocity of the substitutive fan. Therefore:

$$A_w V_w = 8 a_w v_w \text{ or } D_w^2 V_w = 8 d_w^2 v_w \quad (6)$$

$$V_w = 8 \frac{a_w}{A_w} v_w \text{ or } V_w = 8 \left( \frac{d_w}{D_w} \right)^2 v_w \quad (7)$$

Assuming  $V_w = v_w$ , we obtain:  $A_w = 8a_w$  or  $D_w = \sqrt{8}d_w$ . The dimensionless functional relationship for the ventilation tower with one substitutive fan can be defined as follows:

$$\tilde{V}^* = \frac{V_{xp}^*}{V_w} = \tilde{F}^* \left[ \frac{D}{H}; (\tilde{G}_w); \left( \frac{x_p}{H}, \frac{y_p}{H}, \frac{z_p}{H} \right); \text{Re}; \tilde{k}_{rt} \right] \quad (8)$$

where:  $\text{Re} = \frac{V_w H}{\nu}$ .

For comparable parameters of both functions  $\tilde{F}$  and  $\tilde{F}^*$ , it can be stated that  $\tilde{V}^* = \tilde{V}$ . For further considerations of similarity criteria for different setups of stream generation points, it was assumed that they were modelled as ventilation towers with individual substitutive fans.

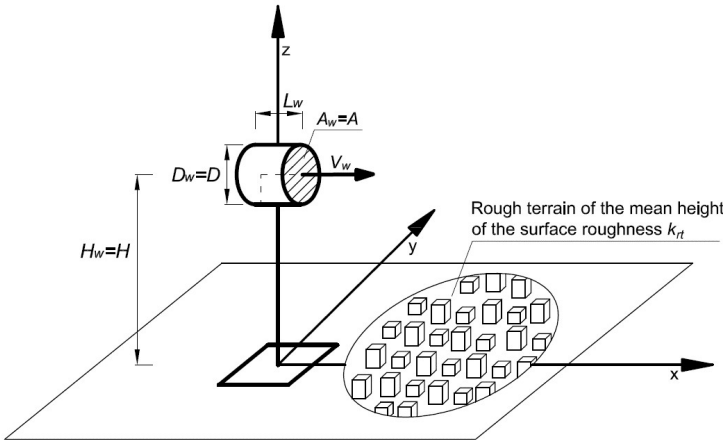

Fig. 4. Sketch of single ventilation tower with one substitutive fan

### 2.1.3. Array of substitutive ventilation towers

Let us now consider a general case for a system of multiple substitutive ventilation towers located at the nodes of a regular mesh where towers are located side-by-side in rows in the y-direction and one-by-one in lines in the x-direction as shown in Fig. 5. Additional parameters that apply here are: distances between rows  $L$ ; distances between the lines  $B$ ; the number of rows  $n_y$ ; the number of lines  $n_x$ .

By conducting the above dimensional analysis, the resulting functional relationship is [23]:

$$\tilde{V}^{**} = \frac{V_{xp}^{**}}{V_w} = \tilde{F}^{**} \left[ \frac{D}{H}, \frac{L}{H}, \frac{B}{H}; (\tilde{G}_w); \left( \frac{x_p}{H}, \frac{y_p}{H}, \frac{z_p}{H} \right); \text{Re}; \tilde{k}_{rt} \right]. \quad (9)$$



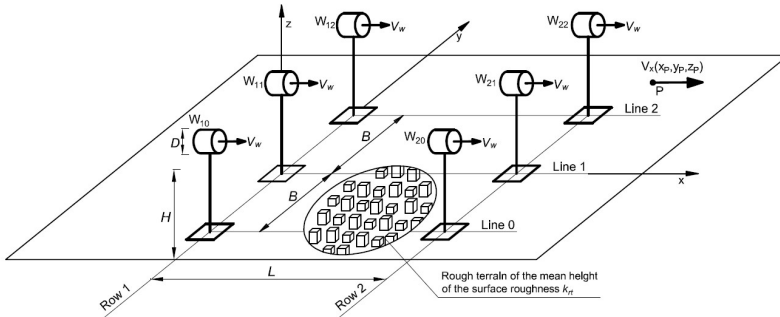

Fig. 5. Six substitutive ventilation towers on a meshed system of two rows and three lines

Based on the considerations given above, one can observe that the air velocity in the elaborated problem is related to the Reynolds number and the distance from the fans. Other geometric parameters are constant. Therefore, the conclusions are as follows: tests results obtained with a scale model are reliable; conditions required to create and maintain airstreams at full scale are the same as for the scale model.

## 2.2. Test models

Aerodynamic models of the ventilation tower were created separately at scales of 1:100 and 1:833. The 1:100 model accurately reflected both height and width (see Fig. 6.b) and also the number of fans. The fan elements of the ventilation towers were modelled with CPU fans of 60 x 60 mm in size. The results obtained in Series I for the 1:100 scale model were satisfactory and were therefore treated as a reference for the results obtained during further tests conducted on a smaller scale (1:833) for Series II – V [24].



a)

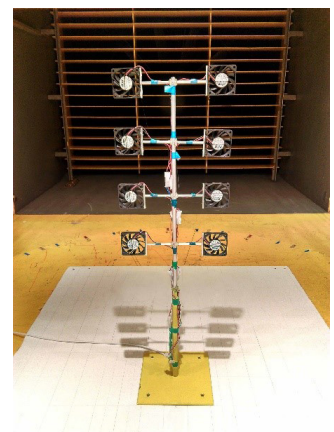

b)

Fig. 6. Models of ventilation towers used in model tests: set of 3 fans – substitutive ventilation towers, at 1:833 scale (a) and single ventilation tower, 1:100 scale (b)

The 1:833 scale was adopted as the most suitable scale for further tests due to the dimensions of the wind tunnel working section, the overall conditions required to generate a continuous airstream by consecutive rows of ventilation towers and available devices (CPU fans) projecting ventilation towers, which are crucial elements of the ventilation system. Each ventilation tower was modelled with the same 60 x 60 mm CPU fan that was used for the 1:100 model scale (see Fig. 6.a). However, such a strategy resulted in different proportions between the height and width of the fans recreating the ventilation towers for the 1:833 scale model and full scale ventilation towers (80 x 20 m). At this scale, only the vertical size was correctly represented (characteristic dimension adopted for further considerations is  $D$  – diameter of fan). Each fan was mounted on a simple construction in order to keep its elevation at the correct level for the chosen modelling scale (see Figs. 8.a & 8.b).



Fig. 7. Styrofoam blocks glued to the board in a pattern recreating terrain roughness for the scale model for categories III (forests and suburban areas) (a) and IV (downtown urban areas) (b) according to [25]

The models were tested in the aerodynamic tunnel of Wind Engineering Laboratory of Cracow University of Technology. The base for the models was made from a smooth wooden board. For Series VII and VIII of the tests, terrain roughness was recreated in the model scale for Categories III (forests and suburban areas) and IV (dense city-centre urban areas) in accordance with [25] (see Fig. 7). This was achieved through the application of rigid Styrofoam blocks glued to the board in a pattern that corresponds with the guidelines of the standard and based on the literature study [6, 20, 26].

### 2.3. Tests and measuring devices

The wind tunnel tests were conducted by measuring wind speed generated by the fans along the  $x$ -axis (see Figs. 9-11). For Series I, tests were conducted at three different heights in order to investigate the three-dimensional distribution of wind speed at each distance from the fans (as shown in Fig. 8.c). For Series II-VIII, tests were conducted at only one height, which was the centre of the fan. Each measurement was performed on four probes. For Series I, measurements were taken at a distance of  $0.6 x/H$  ( $\pm 50$  cm) in the nearest vicinity of the



fans, and then at increasing distances of every  $1.2 x/H$  (100 cm) from the fans (see Table 1). For the rest of the test series, measurement were taken in front of the fans at distances of every  $1.5-3 x/H$  (10 cm) in in close proximity to the fans' and then increasing to every  $4.6 x/H$  (30 cm) from the fans (see Table 1). For Series IV, V and VI, multiple tests were performed at each distance along each line and at the midpoint between them in order to cover all the desired points (as shown in Figs. 8.a & Fig. 8.b).

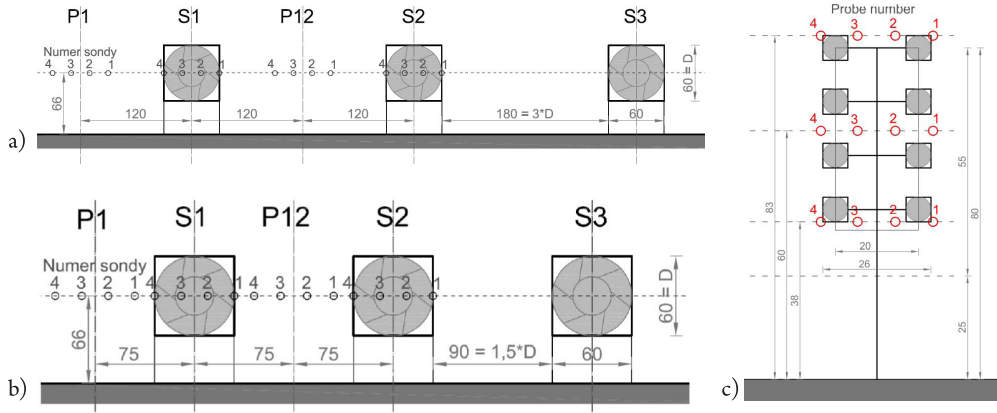

Fig. 8. Scheme of fan configuration and measurement points for: a row of 3 fans spaced at distances of  $3 D$  (180 mm) (a), a row of 3 fans spaced at distances of  $1,5 D$  (90 mm) (b) and a single ventilation tower at a scale of 1:100 (c)

The airstream continuity was investigated by testing the interference of two consecutive fans (or rows of fans). Between the consecutive fans, it was essential to make sure that there would be no point at which the wind speed dropped to the level of background fluctuations or below.

The velocity of the generated air stream was measured using ATU 2001 monofilament hot-wire anemometers. The air stream was generated with CPU fans produced by Xfan, model: RDH6010S1, with a nominal voltage of 12 V, 0.22 A. They were supplied by a stabilised DC power supply. The level of generated wind speed was controlled by adjusting the voltage provided to the fans.

### 3. Experiment implementation and model tests results

The air stream velocity and continuity investigations were conducted in eight different series as presented in Table 1 [24]. Additional two series were conducted to evaluate the influence of terrain roughness Categories III and IV. It was decided that the series of model tests would differ in the number of rows and lines in which the fans were arranged. The distances between fan rows resulting in the generation of the air stream (in order to maintain the air-flow velocity at a specified level) were identified empirically during preliminary model tests.

Table 1. Details of model test series

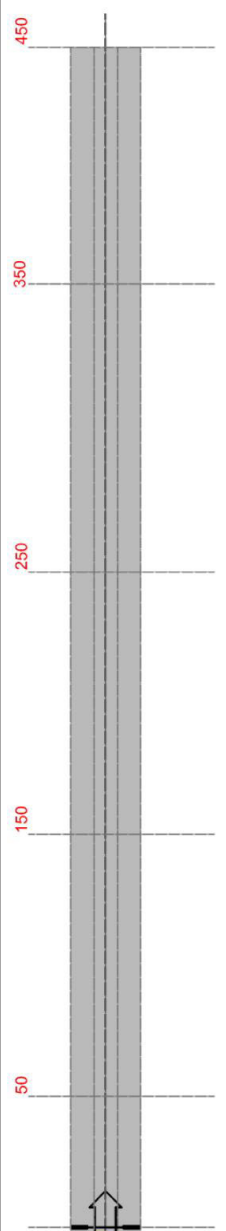
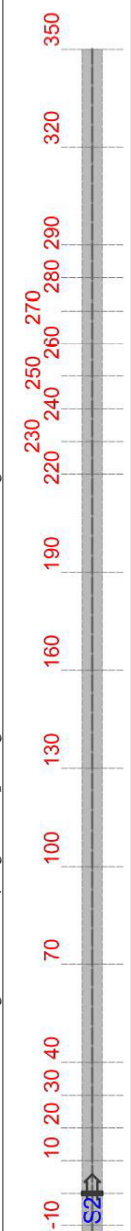
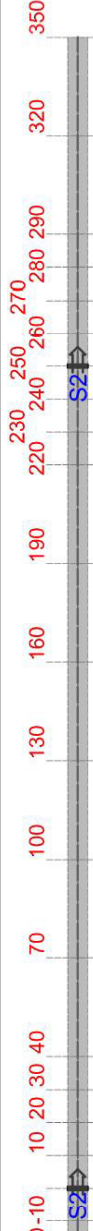
Series no.	Description
Series I	Single ventilation tower at a scale of 1:100, nominal voltage of 13.6 V
	
Series II	Single fan at varying wind speed generated with nominal voltages of 5.6 V, 7.7 V, 9.5 V, 11.4 V, 13.6 V
	
Series III	Two fans placed one by one at a distance of 37.9 x/H (250 cm) and 42.4 x/H (280 cm), nominal voltage of 13.6 V
	
	
Series IV	A row of 3 fans spaced at distances of 1.5 D (90 mm), nominal voltage of 13.6 V
	

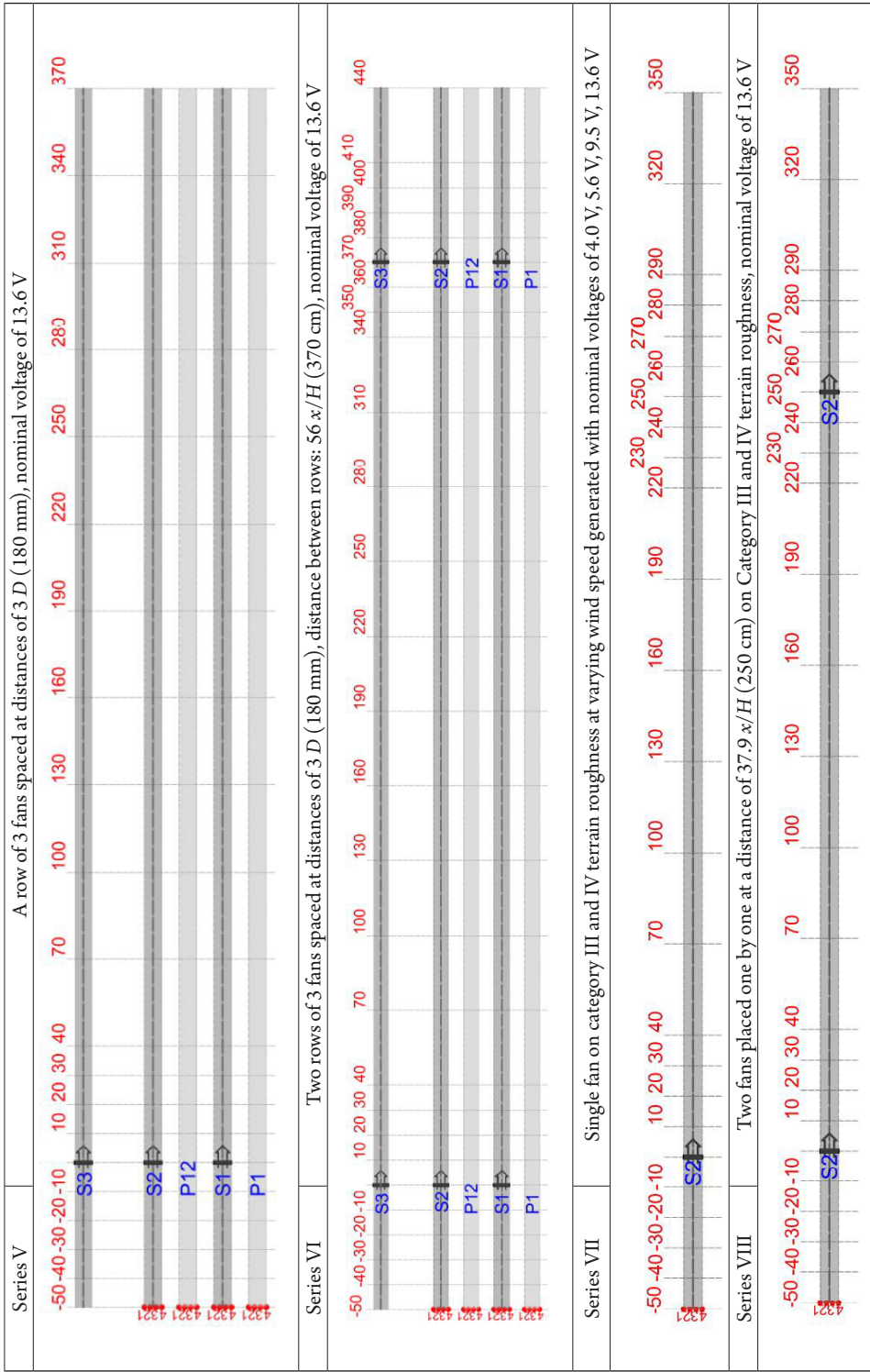

The relative wind velocity distribution is presented in Fig. 9 as a result of tests Series II. It can be observed that at a distance of more than  $4.6 x/H$  (30 cm at the 1:833 experiment scale), the relative wind velocity is maintained on a similar level for every tested rotation speed. This means that the Reynolds number is not a significant factor influencing the results in small scale experiments for the measured range of velocity, as was concluded from the dimensional analysis.

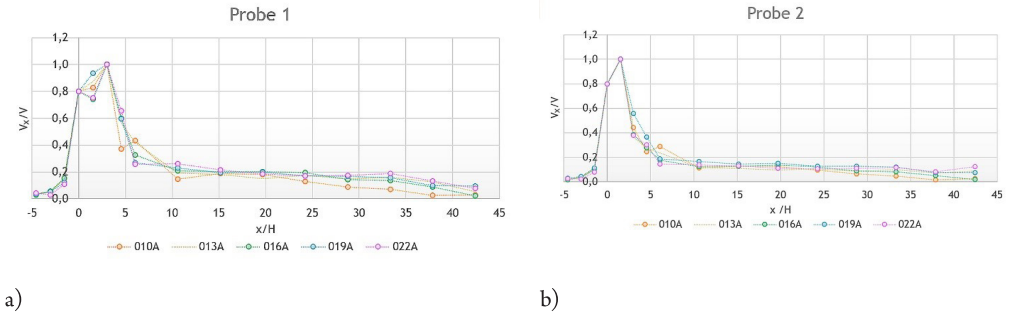

Fig. 9. Model tests results – Series II, comparison of air velocity for different voltages provided to the fans obtained from probe 1 (a) and probe 2 (b)

The range of air suction in front of the fan is limited to no more than  $1.5-3 x/H$  distance (10-20 cm at the scale of the experiment) (see Fig. 9). Thus, it is economically reasonable to place the second row of fans at a distance where the air stream is fading away (see Fig. 10). For this particular study case, the distance was  $42.4 x/H$  (280 cm in experiment scale). Placing the rows of fans closer to each other has an insignificant influence on increasing the air-flow velocity, thus there is no reason for it. However, due to the potential reduction of relative wind velocity caused by adding terrain roughness, a  $37.9 x/H$  (250 cm) distance to the second row of fans was assumed at the initial stage of tests and it was consequently implemented through all series.

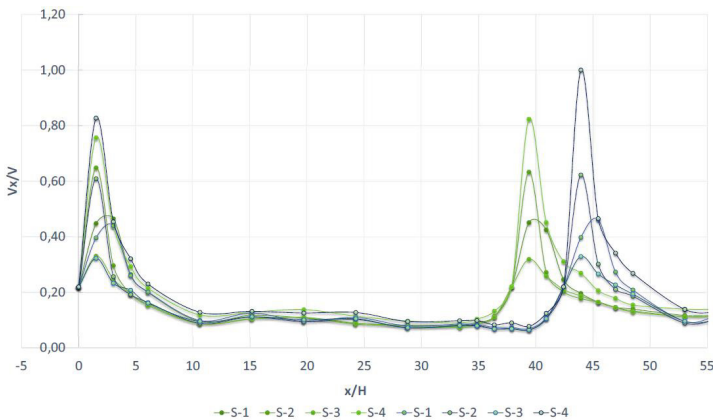

Fig. 10. Model tests results – series III: two fans placed one by one at a distance of  $37.9 x/H$  (250 cm) and  $42.4 x/H$  (280 cm), nominal voltage of 13.6 V

The spread of fans in a single row was evaluated at both  $1.5 D$  (Series III) and  $3 D$  (Series IV). The air flow velocity at the end of the stream (i.e. at a distance of  $56 x/H = 370$  cm at the experiment scale) reached similar values for both cases, although at the spacing of  $3 D$ , the total width of the stream, so also the area of action of the fans, was two times larger than at  $1.5 D$  with the same number of fans (see Fig. 11). Therefore, it was decided to increase the spread of the fans on the ventilation tower to  $3 D$  and continue the tests with this spacing.

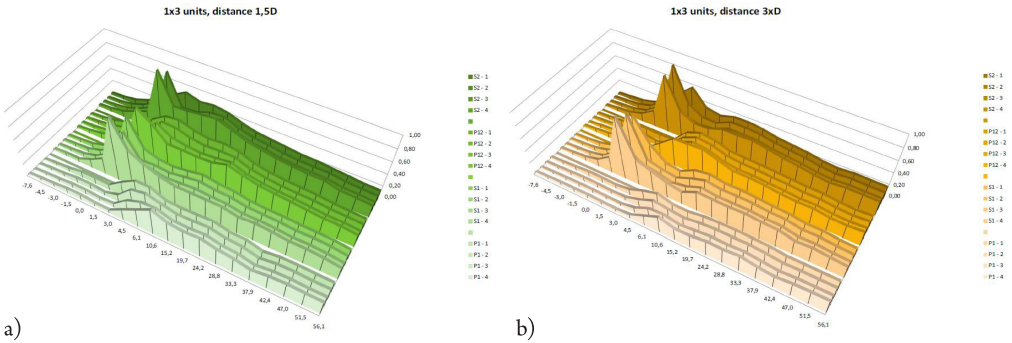

Fig. 11. Model tests results – Series IV & V: a row of 3 fans spaced at distances of  $1.5 D$  (90 mm) (a) and Series IV: a row of 3 fans spaced at distances of  $3 D$  (180 mm) (b)

The wide stream generated with 3 fans spaced at distances of  $3 D$  can be successfully maintained by adding another row of fans at a distance of  $56 x/H$  (370 cm) (see Fig. 12). No significant differences of air flow velocity were observed in close proximity in front of the 2nd row (i.e.  $51.5-54.6 x/H = 340-360$  cm); thus, it was concluded that the location of the 2nd row was correct. Increasing the distance further could result in decreasing the air-flow velocity or even interrupting the continuity of the stream.

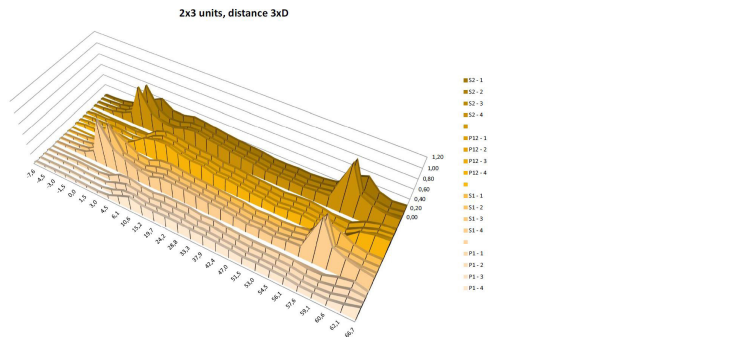

Fig. 12. Model tests results – Series VI: two rows of 3 fans spaced at distances of  $3 D$  (180 mm), distance between rows:  $56 x/H = 370$  cm at the scale of the experiment, nominal voltage of 13.6 V

The relative wind velocity distribution at three different heights for the 1:100 scale model is presented in Fig. 13 as results of Series I (compare to Fig. 8.c). Despite the change of the number of fans from 1 to 8 and the change of scale from 1:833 to 1:100, the flow pattern of

the airstream was similar to the other series. This confirms the thesis that in the model tests, a group of fans operating close to each other can be replaced by a single fan of a larger size.

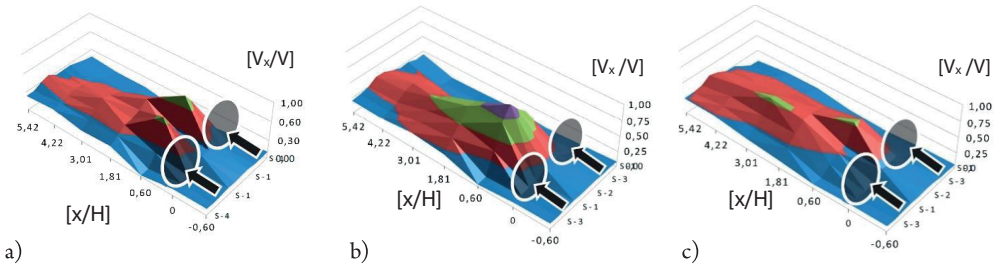

Fig. 13. Model tests results – Series I: relative wind velocity distribution at level 1 = 38 cm (a), level 2 = 60 cm (b) & level 3 = 83 cm (c) for a single ventilation tower at a scale of 1:100, nominal voltage of 13.6 V

A comparison of the results obtained for different nominal voltages of a single fan for terrain categories III & IV is presented in Fig. 14 [27]. The shape of the airstream obtained for Category III of terrain roughness is similar to the shape of the airstream obtained for category 0. One can observe differences in the shape of airstream obtained for terrain Category IV in comparison to other categories. The values of wind speed decreases more rapidly as the distance from the fans increases.

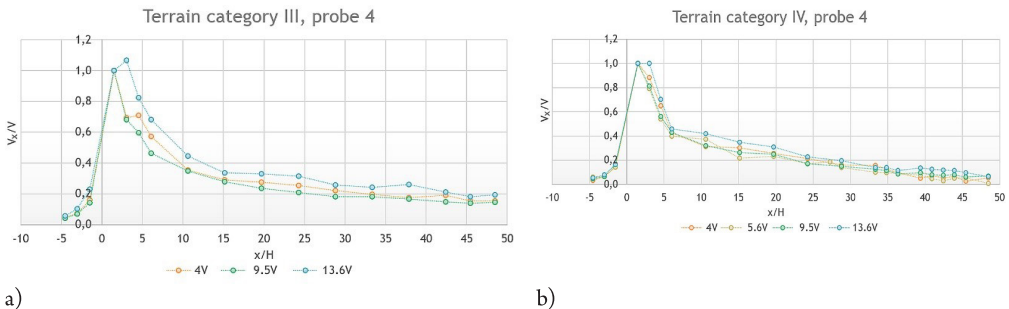

Fig. 14. Model tests results – Series VII, comparison of air velocity for a single fan for different voltage provided to the fan for Category III (a) and IV (b) terrain roughness

The last stage of the analysis presents a comparison of a single fan with two row of fans in the context of different terrain roughness criteria (see Fig. 15.a and 15b) [27]. Analysis shows differences in the shapes of airstreams for terrain categories 0, III & IV. In the case of a single fan, the increase of terrain roughness results in a decreasing airstream velocity. However, a local increase of airstream velocity can be observed for a case of two row of fans for terrain categories III & IV (compare to category 0). This is most likely due to local flow restriction/resistance. In order to determine the local effect of flow restriction/resistance in detail, it is required to conduct more studies, in particular, smoke visualisation research.



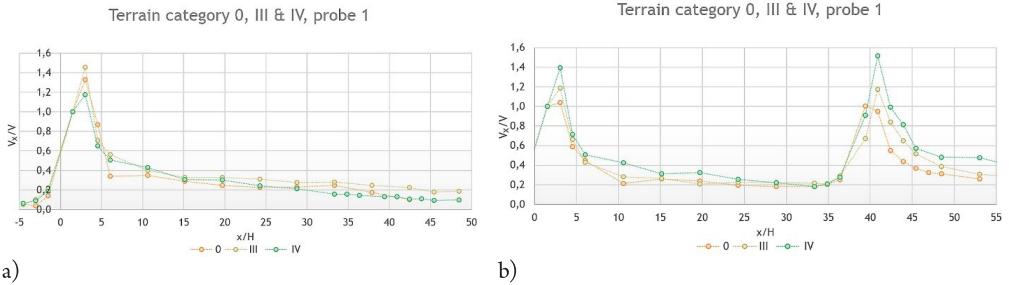

Fig. 15. Model tests results – Series VII & VIII, comparison of air velocity for a single fan (a) and two consecutive fans placed one by one at a distance of  $42.4 x/H$  (b) on Category III and IV terrain roughness, nominal voltage of 13.6 V

#### 4. Results analysis and conclusions

By comparing relative velocity of airstream at a distance further than  $4.6 x/H$  (30 cm) from the fan outlet (which is where the influence of turbulence resulting from fan rotation decreases) for different voltage supplied to the fans, it can be observed that there are no significant differences between them. This means that the influence of the Reynolds number on the phenomenon is negligible for the measured range of velocities, thus the model scale tests may translate to full scale scenarios.

Despite the change in the number of fans from 1 to 8 and the change of the scale from 1:833 to 1:100, the flow patterns of the air streams were similar. This confirms the thesis that in model tests, a group of fans cooperating close to each other can be replaced by a single fan at the smaller scale (i.e. 1:833) as was suggested by the experiments.

The range of air suction behind the fan is limited to only  $1.5-3 x/H$  (10-20 cm). Thus, it is economically reasonable to place another fan in the place where the stream from the preceding fan fades away. This distance was established at  $42.4 x/H$  (280 cm) in the case of one row of fans.

Placing 3 fans in a row increased the distance at which the generated airstream maintained its continuity to  $56 x/H$  (370 cm). Comparing the spacing between fans at  $1.5 D$  (90 mm) and  $3 D$  (180 mm), the latter produced similar wind speeds, but covered a larger area. Thus, the spacing of  $3 D$  (180 mm) between fans in each row was established as the default for further tests.

Adding terrain roughness to the tests only slightly diminished the wind speed of the airstream. It was determined that they kept the same continuity as with the smooth surface, which means they might be used in urban areas in the real world, where the generated airstream would be affected by the buildings [9].

*This work was funded by an internal grant from the Faculty of Civil Engineering of Cracow University of Technology.*

## References

- [1] Błażejczyk K., *System wymiany i regeneracji powietrza jako czynnik poprawy warunków aerosanitarnych i bioklimatycznych w mieście*, Eds: Degórska B., Baścik M., *Środowisko przyrodnicze Krakowa: zasoby - ochrona - kształtowanie*, IGiGP UJ, UMK, WGiK PW, Kraków 2013, 187–190.
- [2] Chu A.K.M., Kwok R.C.W., Yu K.N., *Study of pollution dispersion in urban areas using Computational Fluid Dynamics (CFD) and Geographic Information System (GIS)*, *Environmental Modelling & Software*, 20, 2005, 273–277.
- [3] Wingstedt E.M.M., Osnes A.N., Akerwik E., Eriksson D., Pettersson Reif B.A., *Large-eddy simulation of dense gas dispersion over a simplified urban area*, *Atmospheric Environment* 152, 2017, 605–616.
- [4] Carpentieri M., Robins EnFlo A.G., *Wind tunnel experiments of flow and dispersion in a real urban area*, The 7<sup>th</sup> International Conference on Urban Climate, 29 June – 3 July, Yokohama 2009.
- [5] Buccolieri R., Sandberg M., Di Sabatino S., *City breathability and its link to pollutant concentration distribution within urban-like geometries*, *Atmospheric Environment* 44, 2010, 1894–1903.
- [6] Ramponi R., Blocken B., de Coo L.B., Janssen W. D., *CFD simulation of outdoor ventilation of generic urban configurations with different urban densities and equal and unequal street widths*, *Building and Environment* 92, 2015, 152–166.
- [7] Oke T.R., *Boundary layer climates*, Methuen, New York 1978.
- [8] Sorbjan Z., *Turbulence and diffusion in the lower atmosphere*, PWN, Warszawa 1983.
- [9] Hang J., Sandberg M., Li Y., *Effect of urban morphology on wind condition in idealized city models*, *Atmospheric Environment* 43, 2009, 869–878.
- [10] Jiang Y., Alexander D., Jenkins H., Arthur R., Chen Q., *Natural ventilation in buildings, measurement in a wind tunnel and numerical simulation with large-eddy simulation*, *Journal of Wind Engineering and Industrial Aerodynamics* 91, 2003, 331–353.
- [11] Omrani S., Garcia-Hansen V., Capra B., Drogemuller R., *Natural ventilation in multi-storey buildings, Design process and review of evaluation tools*, *Building and Environment* 116, 2017, 182–194.
- [12] Yang L., Qian F., Song D.X., Zheng K.J., *Research on Urban Heat-island Effect*, *Procedia Engineering* 169, 2016, 11–18.
- [13] Yang L., Li Y., *Thermal conditions and ventilation in an ideal city model of Hong Kong*, *Energy and Buildings* 43, 2011, 1139–1148.
- [14] Lewińska J., *Klimat miasta. Vademecum urbanisty*, Instytut Gospodarki Przestrzennej i Komunalnej, Oddział w Krakowie, 1991.
- [15] Cao Z., Wang Y., Duan M., Zhu H., *Study of the vortex principle for improving the efficiency of an exhaust ventilation system*, *Energy and Buildings* 142, 2017, 39–48.
- [16] US 4164256 A, Cooling tower with forced ventilation and natural draft.
- [17] US 5425413 A, Method to hinder the formation and to break-up overhead atmospheric inversions, enhance ground level air circulation and improve urban air quality.

- [18] Spurr G., *The penetration of atmospheric inversions by hot plumes*, Journal of Meteorology, Vol. 16, 30–37, 1959.
- [19] DE 3503138 A1, *Process for reducing smog by the chimney inversion/injector effect*.
- [20] Blackman K., Perret L., Savory E., Piquet T., *Field and wind tunnel modelling of an idealized street canyon flow*, Atmospheric Environment 106, 2015, 139–153.
- [21] Zhai Z.J., Brannon B., *Performance comparison of destratification fans for large spaces*, Procedia Engineering 146, 2016, 40–46.
- [22] CN 203620447 U, *Device for preventing pollution of air suspended particles in urban industrial district*.
- [23] Flaga A., *Kryteria podobieństwa modelowego dla równoległego układu wież wentylacyjnych*, Research Report, Wind Engineering Laboratory, Cracow University of Technology, Kraków 2017.
- [24] Flaga A., Flaga Ł., Krajewski P., Pistol A., *Badania wstępne możliwości dynamicznego oddziaływania na warstwę przyziemną. Etap I – Pomiar pola prędkości przepływu i zasięgu strumienia powietrza generowanego przez modele wentylatorów/wież wentylacyjnych w różnych wariantach ich konfiguracji*, Research Report, Wind Engineering Laboratory, Cracow University of Technology, Kraków 2017.
- [25] PN-EN 1991-1-4. Eurokod 1. Oddziaływania na konstrukcje. Część 1-4, Oddziaływania ogólne – Oddziaływania wiatru [in Polish].
- [26] Flaga A., *Inżynieria wiatrowa. Podstawy i zastosowania*, Arkady, Warszawa 2008.
- [27] Flaga A., Flaga Ł., Krajewski P., Pistol A., *Badania wstępne możliwości dynamicznego oddziaływania na warstwę przyziemną. Etap III – Badania w tunelu aerodynamicznym wybranych zagadnień z Etapów I i II przy uwzględnieniu wpływu chropowatości podłoża, zabudowy miejskiej*, Research Report, Wind Engineering Laboratory, Cracow University of Technology, Kraków 2017.